

You can't beat the system.®

Cast Iron

TECHNICAL AND INSTALLATION MANUAL

(Updated December 1, 2022)

INTRODUCTION

As the leading manufacturer of cast iron soil pipe and fittings, Charlotte Pipe and Foundry can be your one-stop source for all your cast iron piping system needs. We manufacture a full line of Service and Extra Heavy cast iron soil pipe and fittings from 2" - 15", and Double-Hub pipe from 2" - 6". We also manufacture a full line of No-Hub (hubless) pipe and fittings, 1½" - 15". All of our products are proudly **made in the U.S.A.** and meet or exceed all applicable ASTM and CISPI standards.

Charlotte Pipe® has been relentless in our commitment to quality and service for more than a century. Through the years we have broadened and enhanced our product lines to meet customer demand. We've focused on continuous process improvement to serve you better. All told, we've invested millions to improve manufacturing efficiency, productivity and capacity, making our foundry one of the most modern of its type in the world.



Charlotte Pipe and Foundry Company, Cast Iron Division

We appreciate your business and we look forward to serving your need for information and premium-quality cast iron plumbing systems. You may also find the safety and technical information contained in this manual on our web site, www.charlottepipe.com.

You can't beat the system.®

TABLE OF CONTENTS

GENERAL INFORMATION	Page
Introduction	2
Understanding Safety Alert Messages	5
Components of the DWV System	6
Performance	6-8
Resistance to Abrasion.....	7
The Green Choice.....	7
Soundproofing Qualities of Cast Iron Systems.....	7-8
Product Availability.....	8
Receiving, Handling and Storage of Cast Iron Pipe and Fittings	8-9
Receiving Cast Iron Shipments.....	8
Storage of Pipe and Fittings.....	8
Physical Properties of Gray Iron.....	9
Product Submittals	10-12
Service Cast Iron Soil Pipe and Fittings	10
Extra Heavy Cast Iron Soil Pipe and Fittings.....	11
No-Hub (Hubless) Cast Iron Soil Pipe and Fittings.....	12
Product Certification	13
Product Data	14-20
Service Cast Iron.....	14-15
Extra Heavy Cast Iron.....	16-17
Dimensional Tolerances for Extra Heavy and Service Cast Iron	
Soil Pipe & Fittings.....	18
Hubless Cast Iron	19-20
DESIGN AND ENGINEERING DATA	
Gravity Flow	21
Manning Roughness Factor (“N” Value).....	21
“N” Values for Typical Piping Materials.....	21
Self-cleansing Velocities	21
Design of Sewer and Drains.....	21
Fluid Flow Properties	22-27
Velocity Charts.....	22-27
Support Spacing and Hangers	28
Fire Resistance of Cast Iron Systems	28
Reference Standards	29

TABLE OF CONTENTS

INSTALLATION PROCEDURES FOR CAST IRON

Cutting Methods for Cast Iron Soil Pipe	30
Cutting Cast Iron Soil Pipe with a Snap Cutter	30
Joining Methods for Cast Iron Soil Pipe	31-34
Compression Gaskets	31
Making a Compression-gasket Joint	32-33
Installing Fittings with Compression-gasket Joints	33-34
Important Reminders and Helpful Hints about Compression-gasket Joints.....	34
Hubless Joints	35-40
Making Hubless Joints.....	36-37
Underground Installation Procedures	37-38
Under-slab Installation	38
Above-ground Installation Procedures	38-39
Installing Vertical Piping	38-39
Installing Horizontal Piping - Suspended	39
Installing Horizontal Fittings	39

TESTING AND INSPECTION

Water or Hydrostatic Testing.....	40
Thrust Forces	41
The Smoke Test	42
The Peppermint Test	42

SPECIAL CONSIDERATIONS

How to Determine Right- or Left-hand Inlets	43
Painting Cast Iron Soil Pipe	43
Siphonic Roof Drains	43

MATERIAL SELECTION AND ENGINEERING CONSIDERATIONS

Material Selection and Engineering Considerations	44-45
Maximum Working Temperature	44
Thermal Expansion.....	44
Sound Attenuation.....	44
Burial of Cast Iron.....	44
Hanger Spacing & Fall	45
Combustibility & Use in Plenum Spaces.....	45
Engineered Applications	45
The Original Green Piping System	45

LIMITED WARRANTY	46
-------------------------------	----

Understanding Safety Alert Messages

It is important to read and understand this manual. It contains information to help protect your safety and prevent problems.



This is the safety alert symbol. It is used to alert you to potential personal injury hazards. Obey all safety messages that follow this symbol to avoid personal injury or death.

WARNING

“WARNING” Indicates a hazardous situation which, if not avoided, could result in severe injury or death.

CAUTION

“CAUTION” Indicates a hazardous situation which, if not avoided, could result in minor or moderate injury.

NOTICE

“NOTICE” Indicates a hazardous situation which, if not avoided, may result in system failure and property damage.

READ & SAVE THESE INSTRUCTIONS

COMPONENTS OF THE DWV SYSTEM

Engineers and designers have a number of materials from which to choose as they design sanitary and storm drainage systems for residential and commercial projects. Due to its exceptional strength and combination of being non-combustible and extremely quiet, cast iron soil pipe is a very popular choice for commercial construction. Upscale homes often feature cast iron stacks combined with plastic used for lavs, showers and tubs for a system Charlotte Pipe calls a "Quiet House[®]" design.

Cast iron soil pipe is primarily used in the construction of buildings. It serves well in sanitary-drain, storm-drain, waste-line, and vent-line applications. The product is widely used in commercial, industrial, and residential construction. Common examples include hospitals, schools, stadiums, prisons, and private dwellings. Cast iron soil pipe is the primary DWV material used in high-rise building construction.

Inside homes and buildings, sanitary piping is installed within partitions and is connected to tubs, lavatories, water closets and other fixtures. The main component of the DWV system is called the cast iron soil stack. This is the vertical piping line that runs upward from the building drain, continues up through the structure, and penetrates the plane of the roof. Waste lines convey waste from the fixtures to the main stack. Vent lines are the system's source of outside air, which allows the system to function properly by preventing a vacuum from forming. Vent lines are tied into the system at a point above the highest fixture. In some installations vent lines are connected to a separate vent stack.

A lower section of horizontal piping within the structure's DWV system is called the drain. It receives discharge from the upper portion of the system and carries it to the building's sewer. The building sewer routes discharge to the point outside the structure prescribed by the local plumbing code, where it connects to the city sewer, or a septic tank.

Within the area of building construction, cast iron soil pipe and fittings are widely used for storm drainage from roofs, yards, areaways, and courts. Cast iron piping is used for collecting runoff from sub-soil drains, which are positioned around the foundation. These drains relieve the foundation from groundwater by channeling it into a storm drainage system, or a sump pump.

Soil pipe also serves well as roof leaders and storm drains.

The design specifications for high-rise structures with large setbacks often call for soil pipe to carry large amounts of rain water and snow melt. Outside the area of building construction and storm drainage, cast iron piping is used in condensate lines, bridge drainage, and swimming pool drainage lines.



PERFORMANCE

Cast Iron is a generic term that identifies a large family of ferrous alloys. Cast irons are primarily alloys of iron that contain more than 2% carbon and 1% or more of silicon. Cast iron can be cast into intricate shapes because of its excellent fluidity. Because of the excellent properties obtainable with these low-cost engineering materials, cast iron finds wide application in environments that demand good corrosion resistance including water, storm and sanitary drain, waste and vent applications.

Quality gray iron castings, like the ones produced by Charlotte Pipe and Foundry, have an abundance of free graphite present in their microstructure. When Charlotte products are exposed to most corrosive agents, an insoluble layer of corrosion protection is left behind, which helps provide a durable barrier against additional corrosion.

Unique corrosion-resistance characteristics make it ideally suited for plumbing applications. The metallurgical composition of our cast iron products, specifically the presence of free graphite, ensures that if there is corrosion, it will occur only on the exposed surface and to extremely shallow depths. The graphite layer prevents additional corrosion.

NOTICE: A small percentage of very special wastes may not be suitable for cast iron plumbing systems. Such waste streams can emanate from laboratories, some concentrated or undiluted carbonated soft drink sources, and sites where specific types of cleaning chemicals are discharged, particularly when the effluent is undiluted. The very low pH wastes from such sources can corrode exposed cast iron.

The pH range for typical DWV systems is between 4.5 and 7. We suggest that the installer establish a uniform slope for horizontal drainage piping, but not less than permitted by applicable plumbing code and in compliance with good plumbing practices, to facilitate flushing of the system. If operating conditions yield an acidity level of pH 4.3 or less, we recommend dilution of the waste stream to raise the pH. If this is not possible, we suggest that the system's designer look into a more suitable material.

The National Bureau of Standards and the Cast Iron Pipe Research Association (now known as the Ductile Iron Pipe Research Association) have studied the underground corrosion of cast iron pipe for many years. As a result of these studies, a procedure has been developed for determining the need for any special corrosion protection. This procedure uses a point system to evaluate five soil characteristics. The procedure and an optional polyethylene film protection system are provided as an appendix to ASTM A 74. Additional information is available from CISPI or Charlotte Pipe.

The corrosion of metals underground is an electrochemical phenomenon of two main types: galvanic and electrolytic.

Galvanic corrosion is self-generating and occurs on the surface of a metal exposed to an electrolyte (such as moist, salt-laden soil). The action is similar to that occurring in a wet- or dry-cell battery. Differences in electrical potential between areas on the surface of the metal (pipe) in contact with such soil may occur for a variety of reasons, including the joining of different metals (iron and copper or brass). Potential differences may also be due to the characteristics of the soil in contact with the pipe surface: e.g. pH, soluble salt, oxygen and moisture content, temperature and the presence of certain bacteria. Any one of a combination of these factors may cause a small amount of electrical current to flow through the soil between areas on the pipe or metal surface. Where this current discharges into the soil from such an area, metal is removed from the pipe surface and corrosion occurs.

Electrolytic corrosion occurs when direct current from outside sources enters and the leaves an underground metal structure such as pipe. At that point where current leaves the metal surface to return to its source through the soil, metal is removed and corrosion occurs.

Over 95 percent of the soil in the United States is non-corrosive to cast iron. Those few soils that are somewhat corrosive to cast iron include natural soils containing high

concentration of decomposing organic matter (swamps, peat bogs, etc.), alkalis or salt (tidal) marshes.

Resistance to Abrasion

Cast iron pipe and fittings are highly resistant to abrasion from sand, gravel, garbage disposal residue, dishwasher discharge, and debris being carried in suspension along the lower portion of the sewer or drain.

The Green Choice

A trend toward environmentally sustainable building practices has grown in recent years. The U.S. government requires that federal government projects use green building practices. Many state and local agencies also offer incentives to encourage the construction of green buildings.

Charlotte Pipe and Foundry certifies that its cast iron pipe and fitting products are made from a minimum of 95% recycled content (0% post-industrial material) and are 100% recyclable. Each year we prevent more than 350 million pounds of scrap iron and steel from entering overcrowded landfills by converting it into cast iron soil pipe and fittings. At the end of the life of a building, the cast iron piping can be recovered and recycled again to make new cast iron pipe and fittings or other metallic products.

While plumbing products themselves cannot earn points toward LEED certification on a project, they do meet the growing demand by project owners and specifiers to employ more "green" products.

The choice is clear when your project calls for recycled or reusable plumbing material; Charlotte Pipe and Foundry.

WARNING

Testing with or use of compressed air or gas in Cast Iron pipe or fittings can result in explosive failures and cause severe injury or death.



- NEVER test with or transport/store compressed air or gas in Cast Iron pipe or fittings.
- NEVER test Cast Iron pipe or fittings with compressed air or gas.
- ONLY use Cast Iron pipe and fittings for drain, waste and vent or sanitary sewer applications.

Soundproofing Qualities of Cast Iron Systems

One of the most significant features of cast iron pipe, compression gaskets and hubless couplings is their sound-deadening quality. The problem of noise is particularly acute in multi-family housing. Although soundproofing has become a major concern in construction design, certain plumbing products have been introduced that not only transmit noise, but may actually amplify it. The use of neoprene gaskets and hubless couplings with cast iron pipe and fittings significantly reduces noise and vibration. As a result of the composition and structure of cast iron, sound is muffled rather than transmitted or amplified, and the neoprene separates the length of pipe and the unit of fittings to help suppress contact-related sound. The result is that objectionable plumbing noises are minimized or eliminated.

Product Availability

Our cast iron foundry is located in Charlotte, North Carolina where all of our products are proudly made in the USA. We have an ample supply of pipe and fittings in stock at all times. Contractors need not be concerned about supply or shortages since the manufacturing capacity is adequate and readily obtainable from Charlotte Pipe.

and stresses normally encountered in transit. The first step upon arrival of the material at the destination should be a thorough inspection for any damage that may have occurred in transit. The shipment will usually be accompanied with a "bill of lading" and a packing slip. The purpose of the bill of lading is the legal transfer of title for the material from the manufacturer to the carrier and from the carrier to the installer or wholesaler who is receiving the shipment. It is essential that any damage or shortage of products be immediately noted on the bill of lading and filed with the carrier involved or Charlotte Pipe within ten (10) days after receipt of product. The bill of lading will reflect total pieces, bundles, or crates. The packing list will give a specific description of each item shipped. It is necessary that the total pieces be checked and any discrepancies noted on the bill of lading before the carrier leaves the delivery destination. Notify Charlotte Pipe of the discrepancies as noted on the bill of lading as soon as possible. Failure to note damage or shortages may result in claims not being honored. A copy of this document should be kept in a safe place if damage or shortages were noted. Charlotte Pipe ships its pipe pre-packaged in bundles and its fittings in boxes for easy unloading. Care should be taken when unloading the unit. Shipping tags are attached to each bundle and box identifying the contents of each unit. These tags should not be removed as they will be useful later in locating items as they are needed.

Storage of Pipe and Fittings

Cast iron pipe and fittings can be stored outside and do not require any special covering to protect them from the elements.

WARNING

To reduce the risk of serious injury, follow the forklift manufacturer's safety precautions. Read and follow all applicable codes and regulations, including 29 C.F.R. 1910.178.

- Pre-packaged bundles of cast iron pipe can weigh hundreds or thousands of pounds; exercise caution when unloading a flatbed truck or moving bundles of pipe around in your yard.
- Pre-packaged fittings come in wooden crates and can also weigh several hundreds of pounds; exercise caution when unloading or moving these crates around.

WARNING

To reduce the risk of serious injury, follow the forklift manufacturer's safety precautions. Read and follow all applicable codes and regulations, including 29 C.F.R. 1910.178.

- Pre-packaged bundles of cast iron pipe can weigh hundreds or thousands of pounds; exercise caution when unloading a flatbed truck or moving bundles of pipe around in your yard.
- Pre-packaged fittings come in wooden crates and can also weigh several hundreds of pounds; exercise caution when unloading or moving these crates around.

RECEIVING, HANDLING AND STORAGE OF CAST IRON PIPE AND FITTINGS

Receiving Cast Iron Shipments

Cast iron pipe and fittings are customarily shipped by flatbed truckloads. Cast iron will withstand the shock

GENERAL INFORMATION

Gray Iron Physical Properties

Tensile Strength	20,000 p.s.i. — 60,000 p.s.i. (21,000 p.s.i.)
Elastic Modulus (Young's modulus)	10 - 23 x 10 ⁶ p.s.i.
Hardness (Brinell)	150 - 250 BHN
Thermal Conductivity	0.110 - 0.137 calories/cm ² /Sec/cm/ °C
Thermal Expansion	10 x 10 ⁻⁶ / °C 6 x 10 ⁻⁶ / °F
Density	0.25 - 0.28 lb./in ³ 6.95 - 7.35 gm/cm ³
Specific Heat	0.13 BTU / lb / °F 0.13 cal / gm / °C

Composition of Gray Iron

The following are typical ranges of elements present in unalloyed gray cast iron normally produced in commercial practice:

Carbon (C)	2.60 - 3.85%
Silicon (Si)	1.25 - 2.90%
Manganese (Mn)	0.40 - 1.00%
Phosphorus (P)	0.02 - 0.90%
Sulfur (S)	0.04 - 0.20%

GENERAL INFORMATION

Cast Iron Installation

SUBMITTAL FOR CHARLOTTE PIPE® SERVICE CAST IRON SOIL PIPE AND FITTINGS

Date: _____

Job Name: _____

Location: _____

Engineer: _____

Contractor: _____

► Scope:

This specification covers Service Cast Iron pipe, fittings, and compression gaskets used in sanitary drain, waste and vent (DWV), sewer, and storm drainage applications. This system is intended for use in non-pressure applications.

► Specification:

Pipe and fittings shall comply with ASTM A 74. Compression gaskets shall comply with ASTM C 564. All pipe and fitting shall be made in the United States, and marked with the collective trademark of the Cast Iron Soil Pipe Institute, ©. Service cast iron pipe and fittings are listed by NSF® International to the UP Code.

► Installation:

Installation shall comply with the latest installation instructions published by Charlotte Pipe and Foundry Company® and shall conform to all applicable plumbing, fire, and building code requirements. The system shall be hydrostatically tested after installation to 10 ft. of head (4.3 psi maximum).

WARNING! Never test with or transport/store compressed air or gas in Cast Iron pipe or fittings. Doing so can result in explosive failures and cause severe injury or death.

► Referenced Standards:

ASTM A 74: Cast Iron Soil Pipe and Fittings

ASTM C 564: Rubber Gaskets for Cast Iron Soil Pipe and Fittings



Not all fitting patterns shown

PIPE - SERVICE					
Size	Telescoping Length Y	Hub I.D. A	Barrel O.D. J	I.D. B	Nominal Thickness T
2"	2.50	2.94	2.30	1.96	0.17
3"	2.75	3.94	3.30	2.96	0.17
4"	3.00	4.94	4.30	3.94	0.18
5"	3.00	5.94	5.30	4.94	0.18
6"	3.00	6.94	6.30	5.94	0.18
8"	3.50	9.25	8.38	7.94	0.23
10"	3.50	11.38	10.50	9.94	0.28
12"	4.24	13.50	12.50	11.94	0.28
15"	4.25	16.95	15.88	15.16	0.36

Charlotte Pipe and Foundry Company • P.O. Box 35430 Charlotte, NC 28235 • (800) 438-6091 • www.charlottepipe.com

Charlotte Pipe and Charlotte Pipe and Foundry Company are registered trademarks of Charlotte Pipe and Foundry Company.

GENERAL INFORMATION

Cast Iron Installation

SUBMITTAL FOR CHARLOTTE PIPE® EXTRA HEAVY CAST IRON SOIL PIPE AND FITTINGS

Date: _____

Job Name: _____

Location: _____

Engineer: _____

Contractor: _____

► **Scope:**

This specification covers Extra Heavy Cast Iron pipe, fittings, and compression gaskets used in sanitary drain, waste and vent (DWV), sewer, and storm drainage applications. This system is intended for use in non-pressure applications.

► **Specification:**

Pipe and fittings shall comply with ASTM A 74. Compression gaskets shall comply with ASTM C 564. All pipe and fitting shall be made in the United States, and marked with the collective trademark of the Cast Iron Soil Pipe Institute, . Extra heavy cast iron pipe and fittings are listed by NSF® International to the UP Code.

► **Installation:**

Installation shall comply with the latest installation instructions published by Charlotte Pipe and Foundry Company® and shall conform to all applicable plumbing, fire, and building code requirements. The system shall be hydrostatically tested after installation to 10 ft. of head (4.3 psi maximum).

WARNING! Never test with or transport/store compressed air or gas in Cast Iron pipe or fittings. Doing so can result in explosive failures and cause severe injury or death.

► **Referenced Standards:**

ASTM A 74: Cast Iron Soil Pipe and Fittings

ASTM C 564: Rubber Gaskets for Cast Iron Soil Pipe and Fittings



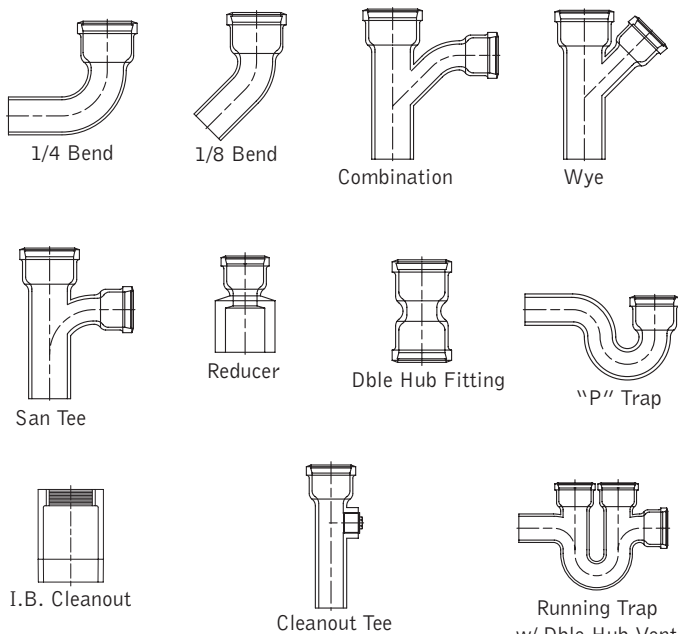

Not all fitting patterns shown

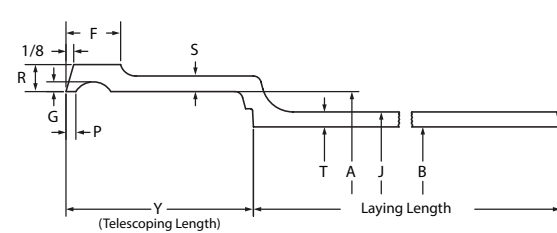

Size	PIPE - EXTRA-HEAVY		Barrel		Nominal Thickness
	Telescoping Length Y	Hub I.D. A	O.D. J	I.D. B	T
2"	2.50	3.06	2.38	2.00	0.19
3"	2.75	4.19	3.50	3.00	0.25
4"	3.00	5.19	4.50	4.00	0.25
5"	3.00	6.19	5.50	5.00	0.25
6"	3.00	7.19	6.50	6.00	0.25
8"	3.50	9.50	8.62	8.00	0.31
10"	3.50	11.62	10.75	10.00	0.37
12"	4.25	13.75	12.75	12.00	0.37
15"	4.25	16.95	15.88	15.00	0.44

Charlotte Pipe and Foundry Company • P.O. Box 35430 Charlotte, NC 28235 • (800) 438-6091 • www.charlottepipe.com

Charlotte Pipe and Charlotte Pipe and Foundry Company are registered trademarks of Charlotte Pipe and Foundry Company.

GENERAL INFORMATION

Cast Iron Installation

SUBMITTAL FOR CHARLOTTE PIPE® HUBLESS CAST IRON SOIL PIPE AND FITTINGS

Date: _____

Job Name: _____

Location: _____

Engineer: _____

Contractor: _____

► Scope:

This specification covers Hubless Cast Iron pipe, fittings, and couplings used in sanitary drain, waste and vent (DWV), sewer, and storm drainage applications. This system is intended for use in non-pressure applications.

► Specification:

Hubless Cast Iron pipe and fittings shall be manufactured from gray cast iron and shall conform to ASTM A 888 and CISPI Standard 301. All pipe and fittings shall be marked with the collective trademark of the Cast Iron Soil Pipe Institute®  and listed by NSF® International. Hubless Couplings shall conform to CISPI Standard 310, shall be manufactured in the United States, and be certified by NSF® International. Heavy Duty and Medium Duty couplings shall conform to ASTM C 1540, shall be manufactured in the United States, and shall be used if indicated.

► Installation:

Installation shall comply with the latest installation instructions published by Charlotte Pipe and Foundry Company® and shall conform to all applicable plumbing, fire, and building code requirements. The system shall be hydrostatically tested after installation to 10 ft. of head (4.3 psi maximum). **WARNING!** Never test with or transport/store compressed air or gas in Cast Iron pipe or fittings. Doing so can result in explosive failures and cause severe injury or death.

► Referenced Standards:

- ASTM C 564: Rubber Gaskets for Cast Iron Soil Pipe and Fittings
- CISPI 301: Hubless Cast Iron Soil Pipe and Fittings
- CISPI 310: Hubless Couplings for Cast Iron Soil Pipe and Fittings
- ASTM C 1277: Hubless Couplings
- ASTM C 1540: Hubless Medium Duty and Heavy Duty Couplings



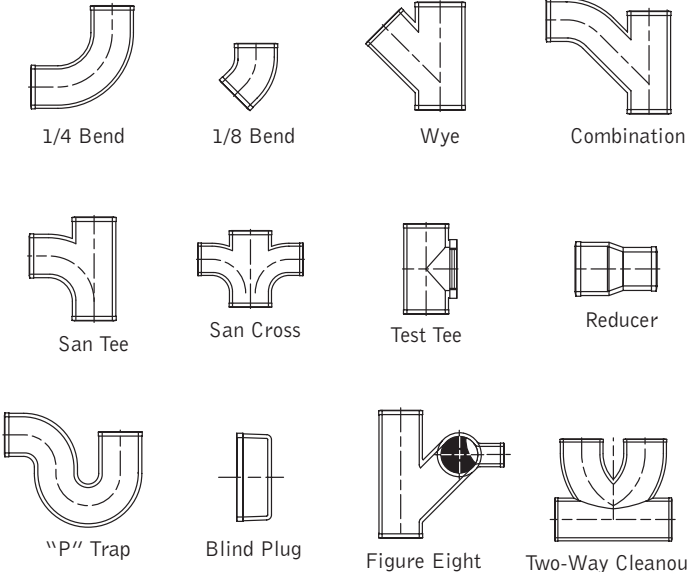

Not all fitting patterns shown

TABLE 1
DIMENSIONS AND TOLERANCES (IN INCHES) OF SPIGOTS AND BARRELS FOR NO-HUB PIPE AND FITTINGS

Size	Inside Barrel Diameter	Outside Diameter Barrel	Outside Diameter Spigot	Width Spigot Bead N	Thickness of Barrel		Gasket Positioning Lug
	B	J	M	(±.13)	T-Nom.	T-Min.	W
1 1/2	1.50 ± .09	1.90 ± .06	1.96 ± .06	.25	.16	.13	1.13
2	1.96 ± .09	2.35 ± .09	2.41 ± .09	.25	.16	.13	1.13
3	2.96 ± .09	3.35 ± .09	3.41 ± .09	.25	.16	.13	1.13
4	3.94 ± .09	4.38 ± .09	4.44 ± .09	.31	.19	.15	1.13
5	4.94 ± .09	5.30 ± .09	5.36 ± .09	.31	.19	.15	1.50
6	5.94 ± .09	6.30 ± .09	6.36 ± .09	.31	.19	.15	1.50
8	7.94 ± .13	8.38 ± .09	8.44 ± .09	.31	.23	.17	2.00
10	10.00 ± .13	10.56 ± .09	10.62 ± .09	.31	.28	.22	2.00
12	11.94 ± .09	12.50 ± .13	12.62 ± .13	.31	.28	.22	2.75
15	15.11 ± .09	15.83 ± .13	16.12 ± .13	.31	.36	.30	2.75

Note: Charlotte Pipe does not recommend or warrant installations joined with unshielded hubless couplings.

Charlotte Pipe and Foundry Company • P.O. Box 35430 Charlotte, NC 28235 • (800) 438-6091 • www.charlottepipe.com

Charlotte Pipe and Charlotte Pipe and Foundry Company are registered trademarks of Charlotte Pipe and Foundry Company.

PRODUCT CERTIFICATION

Specifications Charlotte® Cast Iron Soil Pipe and Fittings

This is to certify that all cast iron pipe and fittings manufactured by Charlotte Pipe and Foundry are made in the United States and conform to the following standards:

SERVICE HUB AND SPIGOT PIPE AND FITTINGS

All cast iron soil pipe and fittings shall be marked with the collective trademark of the Cast Iron Soil Pipe Institute.

ASTM A 74

Listed by NSF® International to the UP Code ISO 9001:2015 Certified

EXTRA HEAVY HUB AND SPIGOT PIPE AND FITTINGS

All cast iron soil pipe and fittings shall be marked with the collective trademark of the Cast Iron Soil Pipe Institute.

ASTM A 74

Listed by NSF® International to the UP Code ISO 9001:2015 Certified

HUBLESS PIPE AND FITTINGS

All cast iron soil pipe and fittings shall be marked with the collective trademark of the Cast Iron Soil Pipe Institute.

CISPI Standard 301

ASTM A 888

Listed by NSF® International to the UP Code ISO 9001:2015 Certified

HUBLESS COUPLINGS

CISPI Standard 310

ASTM C 1277

Certified by NSF® International

HUBLESS HEAVY DUTY COUPLINGS

ASTM C 1540

Factory Mutual 1680

COMPRESSION GASKETS

ASTM C 564

CISPI HSN 85

You can't beat the system.®

WARNING

Testing with or use of compressed air or gas in Cast Iron pipe or fittings can result in explosive failures and cause severe injury or death.

AIR/GAS



- NEVER test with or transport/store compressed air or gas in Cast Iron pipe or fittings.
- NEVER test Cast Iron pipe or fittings with compressed air or gas.
- ONLY use Cast Iron pipe and fittings for drain, waste and vent or sanitary sewer applications.

Service Cast Iron

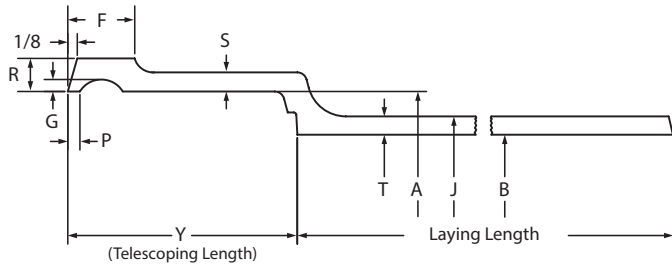

! WARNING

Testing with or use of compressed air or gas in Cast Iron pipe or fittings can result in explosive failures and cause severe injury or death.



- NEVER test with or transport/store compressed air or gas in Cast Iron pipe or fittings.
- NEVER test Cast Iron pipe or fittings with compressed air or gas.
- ONLY use Cast Iron pipe and fittings for drain, waste and vent or sanitary sewer applications.

Service Cast Iron Soil Pipe

Size ^A Availability ^B	Inside Diameter of Hub ^B	Outside Diameter of Barrel	Telescoping Length	Inside Diameter of Barrel	Thickness of Barrel		
	A	J			Y	B	T Nom
2"	2.94	2.30	2.50	1.96		0.17	0.14
3"	3.94	3.30	2.75	2.96		0.17	0.14
4"	4.94	4.30	3.00	3.94		0.18	0.15
5"	5.94	5.30	3.00	4.94		0.18	0.15
6"	6.94	6.30	3.00	5.94		0.18	0.15
8"	9.25	8.38	3.50	7.94		0.23	0.17
10"	11.38	10.50	3.50	9.94		0.28	0.22
12"	13.50	12.50	4.25	11.94		0.28	0.22
15"	16.95	15.88	4.25	15.16		0.36	0.30

Size ^A	Thickness of Hub		Width of Hub Bead	Distance from Lead Groove to End, Pipe and Fittings ^B	Depth of Lead Groove	
	Hub Body	Over Bead			G (min)	G (max)
	S (min)	R (min)	F(min)	P	G (min)	G (max)
2"	0.13	0.34	0.75	0.22	0.10	0.19
3"	0.16	0.37	0.81	0.22	0.10	0.19
4"	0.16	0.37	0.88	0.22	0.10	0.19
5"	0.16	0.37	0.88	0.22	0.10	0.19
6"	0.18	0.37	0.88	0.22	0.10	0.19
8"	0.19	0.44	1.19	0.38	0.15	0.22
10"	0.27	0.53	1.19	0.38	0.15	0.22
12"	0.27	0.53	1.44	0.47	0.15	0.22
15"	0.30	0.58	1.44	0.47	0.15	0.22

^ANominal inside diameter.

^BFor tolerances, please refer to the chart Dimensional Tolerances for Extra Heavy and Service Cast Iron Soli Pipe and Fittings.

! WARNING

Cast Iron pipe and fittings are only intended for DWV (drain, waste and vent) non-pressure applications. Using cast iron pipe and fittings in pressure applications could result in explosive failures, causing serious injury or death or property damage.

Service Cast Iron

Service Cast Iron Soil Pipe

Part No. SV 1
Pipe, 5' Lengths, Single Hub



Size	Weight
2"x5'	23.8
3"x5'	31.8
4"x5'	41.0
5"x5'	52.5
6"x5'	69.2
8"x5'	101.0
10"x5'	150.9
12"x5'	197.3
15"x5'	302.7

Part No. SV 4
Pipe, 30" Lengths, Double Hub



Size	Weight
2"x30"	13.8
3"x30"	17.6
4"x30"	27.1

Part No. SV 3
Pipe, 10' Lengths, Single Hub



Size	Weight
2"x10'	40.1
3"x10'	59.5
4"x10'	75.1
5"x10'	100.4
6"x10'	122.8
8"x10'	180.5
10"x10'	259.7
12"x10'	345.9
15"x10'	525.1

WARNING

Testing with or use of compressed air or gas in Cast Iron pipe or fittings can result in explosive failures and cause severe injury or death.



- NEVER test with or transport/store compressed air or gas in Cast Iron pipe or fittings.
- NEVER test Cast Iron pipe or fittings with compressed air or gas.
- ONLY use Cast Iron pipe and fittings for drain, waste and vent or sanitary sewer applications.

Extra Heavy Cast Iron

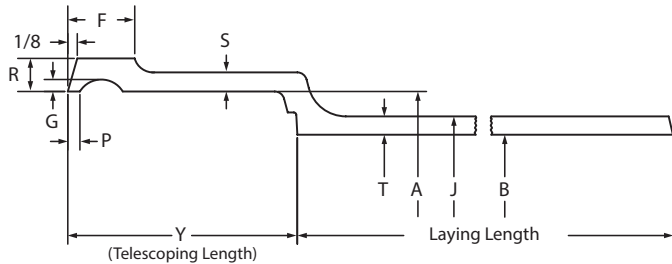

! WARNING

Testing with or use of compressed air or gas in Cast Iron pipe or fittings can result in explosive failures and cause severe injury or death.

- NEVER test with or transport/store compressed air or gas in Cast Iron pipe or fittings.
- NEVER test Cast Iron pipe or fittings with compressed air or gas.
- ONLY use Cast Iron pipe and fittings for drain, waste and vent or sanitary sewer applications.

Extra Heavy Cast Iron Soil Pipe and Fittings:

Size ^A Availability ^B	Inside Diameter of Hub ^B	Outside Diameter of Barrel ^B	Telescoping Length ^B	Inside Diameter of Barrel ^B	Thickness of Barrel ^B	
	A	J	Y	B	T	
					Nom	Min
2"	3.06	2.38	2.50	2.00	0.19	0.16
3"	4.19	3.50	2.75	3.00	0.25	0.22
4"	5.19	4.50	3.00	4.00	0.25	0.22
5"	6.19	5.50	3.00	5.00	0.25	0.22
6"	7.19	6.50	3.00	6.00	0.25	0.22
8"	9.50	8.62	3.50	8.00	0.31	0.25
10"	11.62	10.75	3.50	10.00	0.37	0.31
12"	13.75	12.75	4.25	12.00	0.37	0.31
15"	16.95	15.88	4.25	15.00	0.44	0.38

Size ^A	Thickness of Hub		Width of Hub Bead ^B	Distance from Lead Groove to End, Pipe and Fittings ^B	Depth of Lead Groove	
	Hub Body	Over Bead				
	S (min)	R (min)	F	P	G (min)	G (max)
2"	0.18	0.37	0.75	0.22	0.10	0.19
3"	0.25	0.43	0.81	0.22	0.10	0.19
4"	0.25	0.43	0.88	0.22	0.10	0.19
5"	0.25	0.43	0.88	0.22	0.10	0.19
6"	0.25	0.43	0.88	0.22	0.10	0.19
8"	0.34	0.59	1.19	0.38	0.15	0.22
10"	0.40	0.65	1.19	0.38	0.15	0.22
12"	0.40	0.65	1.44	0.47	0.15	0.22
15"	0.46	0.71	1.44	0.47	0.15	0.22

^ANominal inside diameter.

^BFor tolerances, please refer to the chart Dimensional Tolerances for Extra Heavy and Service Cast Iron Soli Pipe and Fittings.

! WARNING

Cast Iron pipe and fittings are only intended for DWV (drain, waste and vent) non-pressure applications. Using cast iron pipe and fittings in pressure applications could result in explosive failures, causing serious injury or death or property damage.

Extra Heavy Cast Iron

Extra Heavy Cast Iron Soil Pipe

Part No. XH 1
Pipe, 5' Lengths, Single Hub



Size	Weight
2"x5'	25.0
3"x5'	44.4
4"x5'	59.6
5"x5'	73.7
6"x5'	81.4
8"x5'	141.1
10"x5'	196.7
12"x5'	245.2
15"x5'	350.0

Part No. XH 4
Pipe, 30" Lengths, Double Hub



Size	Weight
2"x30"	15.0
3"x30"	26.0
4"x30"	33.0

Part No. XH 3
Pipe, 10' Lengths, Single Hub



Size	Weight
2"x10'	45.3
3"x10'	83.9
4"x10'	104.9
5"x10'	134.3
6"x10'	156.6
8"x10'	246.1
10"x10'	375.4
12"x10'	471.0
15"x10'	676.4

WARNING

Testing with or use of compressed air or gas in Cast Iron pipe or fittings can result in explosive failures and cause severe injury or death.

AIR/GAS

- NEVER test with or transport/store compressed air or gas in Cast Iron pipe or fittings.
- NEVER test Cast Iron pipe or fittings with compressed air or gas.
- ONLY use Cast Iron pipe and fittings for drain, waste and vent or sanitary sewer applications.

GENERAL INFORMATION

Cast Iron Installation

DIMENSIONAL TOLERANCES FOR EXTRA HEAVY AND SERVICE CAST IRON SOIL PIPE & FITTINGS

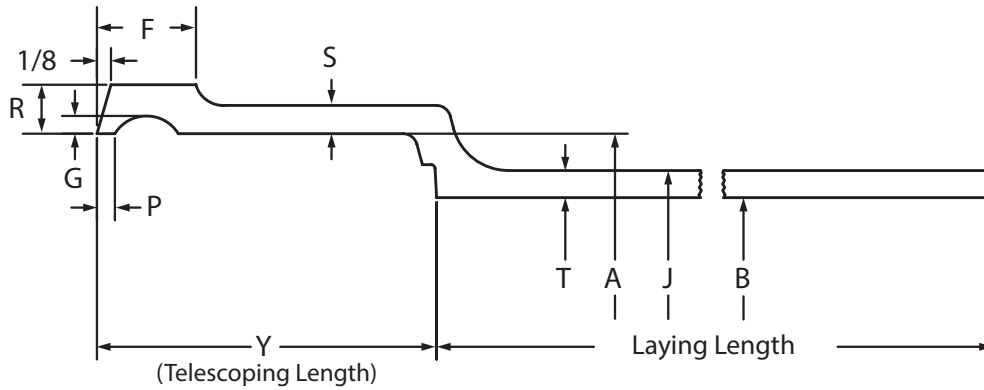

Size ^A	Inside Diameter of Hub	Outside Diameter of Barrel	Inside Diameter of Barrel	Tele-scoping Length	Laying Length			
	A'	J	B	Y	Pipe, 2½-, 3½-, 5-ft Lengths	Pipe, 10-ft Lengths	Fittings	
							Regular	Extra Long ^B
2	±0.06	±0.09	±0.09	±0.06	±1/4	±1/2	±1/8	±1/16
3	+0.09	±0.09	±0.09	±0.06	±1/4	±1/2	±1/8	±1/16
4	-0.06	±0.09	±0.09	±0.06	±1/4	±1/2	±1/8	±1/16
5	+0.09	±0.09	±0.09	±0.06	±5/16	±5/8	±3/16	±3/32
6	-0.06	±0.09	±0.09	±0.06	±5/16	±5/8	±3/16	±3/32
8	+0.09	±0.09	±0.09	±0.06	±5/16	±5/8	±3/16	±3/32
10	-0.06	±0.09	±0.09	±0.06	±5/16	±5/8	±3/16	±3/32
12	±0.13	±0.13	±0.13	±0.13	±3/8	±3/4	±1/4	±1/8
15	±0.13	±0.19	±0.19	±0.19	±3/8	±3/4	±1/4	±1/8

Size	Width of Hub Bead	Distance from Lead Groove to End, Pipe and Fittings
	F	P
2	-0.13	±0.09
3	-0.13	±0.09
4	-0.13	±0.09
5	-0.13	±0.09
6	-0.13	±0.09
8	-0.13	±0.09
10	0.13	±0.09
12	-0.13	±0.11
15	-0.13	±0.11

^A Nominal inside diameter.

^B These tolerances apply to each foot of extra-long fittings in excess of regular laying lengths specified herein.

Hubless Cast Iron

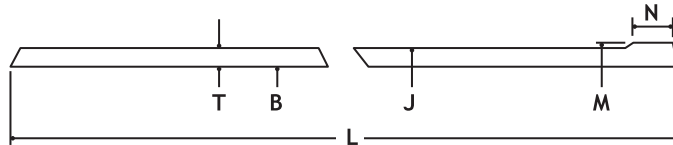

DIMENSIONS AND TOLERANCES (IN INCHES) OF SPIGOTS AND BARRELS FOR HUBLESS PIPE AND FITTINGS

Size	Inside Barrel Diameter	Outside Diameter Barrel	Outside Diameter Spigot	Width Spigot Bead N	Thickness of Barrel		Gasket Positioning Lug
	B	J	M	(± .13)	T-Nom.	T-Min.	W
1½	1.50 ± .09	1.90 ± .06	1.96 ± .06	.25	.16	.13	1.13
2	1.96 ± .09	2.35 ± .09	2.41 ± .09	.25	.16	.13	1.13
3	2.96 ± .09	3.35 ± .09	3.41 ± .09	.25	.16	.13	1.13
4	3.94 ± .09	4.38 ± .09	4.44 ± .09	.31	.19	.15	1.13
5	4.94 ± .09	5.30 ± .09 -.05	5.36 ± .09	.31	.19	.15	1.50
6	5.94 ± .09	6.30 ± .09 -.05	6.36 ± .09	.31	.19	.15	1.50
8	7.94 ± .13	8.38 ± .09	8.44 ± .09	.31	.23	.17	2.00
10	10.00 ± .13	10.56 ± .09	10.62 ± .09	.31	.28	.22	2.00
12	11.94 ± .09	12.50 ± .13	12.62 ± .13	.31	.28	.22	2.75
15	15.11 ± .09	15.83 ± .13	16.12 ± .13	.31	.36	.30	2.75

WARNING

Cast Iron pipe and fittings are only intended for DWV (drain, waste and vent) non-pressure applications. Using cast iron pipe and fittings in pressure applications could result in explosive failures, causing serious injury or death or property damage.

WARNING

Testing with or use of compressed air or gas in Cast Iron pipe or fittings can result in explosive failures and cause severe injury or death.

AIR/GAS

- NEVER test with or transport/store compressed air or gas in Cast Iron pipe or fittings.
- NEVER test Cast Iron pipe or fittings with compressed air or gas.
- ONLY use Cast Iron pipe and fittings for drain, waste and vent or sanitary sewer applications.

Hubless Cast Iron

Hubless Cast Iron Soil Pipe

Part No. NH 2
No-Hub (Hubless) Pipe

USA CHARLOTTE PIPE USA

Size	Weight
1½"x10'	28.5
2"x10'	35.0
3"x10'	54.0
4"x10'	76.0
5"x10'	97.6
6"x10'	117.8
8"x10'	170.9
10"x10'	254.6
12"x10'	318.1
15"x10'	492.6



WARNING

Cast Iron pipe and fittings are only intended for DWV (drain, waste and vent) non-pressure applications. Using cast iron pipe and fittings in pressure applications could result in explosive failures, causing serious injury or death or property damage.



WARNING

Testing with or use of compressed air or gas in Cast Iron pipe or fittings can result in explosive failures and cause severe injury or death.

AIR/GAS



- NEVER test with or transport/store compressed air or gas in Cast Iron pipe or fittings.
- NEVER test Cast Iron pipe or fittings with compressed air or gas.
- ONLY use Cast Iron pipe and fittings for drain, waste and vent or sanitary sewer applications.

GRAVITY FLOW

Manning Roughness Factor (“N” Value)

Fluid velocity, pipe size and hydraulic slope for gravity drainage can be determined using the Manning “N” value. This coefficient relates to the interior wall smoothness of pipe and is used for liquids with a steady flow, at a constant depth, in a prismatic open channel. The Manning’s equation is shown below:

$$V = \frac{1.486 R^{2/3} S^{1/2}}{N}$$

Where:

V = Velocity of flow, ft./second

N = Manning’s value

r = hydraulic radius, ft. obtained by dividing the cross sectional area of flow by the wetted perimeter of the pipe in contact with the flow. R is a special case for v with pipes either 1/2 full or full:

R = Inside diameter / 4, in feet

S = $\frac{\text{Upstream elevation} - \text{Down stream elevation}}{\text{pipe length}}$ (ft./ft.)

“N” Values For Typical Piping Materials

Piping Material	“N” Values
Cast Iron	.011 - .015
Finished Concrete	.011 - .015
Unfinished Concrete	.013 - .017
Corrugated Metal	.021 - .027
Glass	.009 - .013
Clay	.011 - .017

Self-cleansing Velocities

Table 1 on the following page indicates the slopes required to obtain self-cleansing or scouring velocities at various rates of discharge. A self-cleansing velocity, or one sufficient to carry sewage solids along the pipe, permits the system to operate efficiently and reduces the likelihood of stoppages. A minimum velocity of 2 feet per second is the generally prescribed norm consistent with the removal of sewage solids, but a velocity of 2.5 feet per second can be used in cases where an additional

degree of flow is desired. In addition to designing self-cleansing velocities into sanitary sewers, it is considered good practice to impose an upper-velocity limit of 10 feet per second in both sewers and drains. This restricts the abrasive action of sand and grit that may be carried through the system. However, because cast iron soil pipe is highly resistant to abrasion, it is most suitable for use where high-velocity operation cannot be avoided.

Design of Sewer and Drains

Table 2 on the following pages provides data to help determine the adequate size of the cast iron soil pipe to accommodate the expected peak flow at a designed, self-cleansing velocity. The peak flow that governs design is that projected to occur in the future during the service life of the particular system.

The factors affecting peak flow vary with the type of system to be installed. In a sanitary sewer for domestic waste, the maximum quantity of sewage depends primarily upon the density and distribution of the population and its per capita use of water. In a sewer for commercial and industrial waste, it depends on the number and type of businesses to be serviced by the system. The peak load in a storm sewer, on the other hand, is determined by the duration and intensity of rainfall and the extent, condition and slope of streets and other areas requiring drainage.

For a particular hydraulic system, the factors affecting peak flow are analyzed by means of procedures in design handbooks. Unfortunately, this analysis is generally imperfect from the standpoint of system design. In most cases, current peak flow can be accurately quantified, but only a rough approximation can be made of future peak flow, which is usually based on population trends and area development over a period of fifty or so years. This requires that provisions be made for any unforeseen increase in runoff, and therefore, cast iron soil pipe hydraulic systems are most frequently designed for half-full operation at probable future peak flow. Greater or less than half-full operation can be employed, depending on design requirements and the relative accuracy with which future flow can be forecast.

FLUID FLOW PROPERTIES

TABLE 1
Slopes of Cast Iron Soil Pipe Sanitary Sewers
Required to Obtain Self-Cleaning Velocities of 2.0 and 2.5 Ft./Sec.
(Based on Manning's Formula with N = .012)

Pipe Size (In.)	Velocity (Ft./Sec.)	<u>¼ FULL</u>		<u>½ FULL</u>		<u>¾ FULL</u>		<u>FULL</u>	
		Slope (Ft./Ft.)	Flow (Gal./Min.)	Slope (Ft./Ft.)	Flow (Gal./Min.)	Slope (Ft./Ft.)	Flow (Gal./Min.)	Slope (Ft./Ft.)	Flow (Gal./Min.)
2.0	2.0	0.0313	4.67	0.0186	9.34	0.0148	14.09	0.0186	18.76
	2.5	0.0489	5.84	0.0291	11.67	0.0231	17.62	0.0291	23.45
3.0	2.0	0.0178	10.77	0.0107	21.46	0.0085	32.23	0.0107	42.91
	2.5	0.0278	13.47	0.0167	26.82	0.0133	40.29	0.0167	53.64
4.0	2.0	0.0122	19.03	0.0073	38.06	0.0058	57.01	0.0073	76.04
	2.5	0.0191	23.79	0.0114	47.58	0.0091	71.26	0.0114	95.05
5.0	2.0	0.0090	29.89	0.0054	59.79	0.0043	89.59	0.0054	119.49
	2.5	0.0141	37.37	0.0085	74.74	0.0067	11.99	0.0085	149.36
6.0	2.0	0.0071	43.18	0.0042	86.36	0.0034	129.54	0.0042	172.72
	2.5	0.0111	53.98	0.0066	107.95	0.0053	161.93	0.0066	214.90
8.0	2.0	0.0048	77.20	0.0029	154.32	0.0023	231.52	0.0029	308.64
	2.5	0.0075	96.50	0.0045	192.90	0.0036	289.40	0.0045	385.79
10.0	2.0	0.0036	120.92	0.0021	241.85	0.0017	362.77	0.0021	483.69
	2.5	0.0056	151.15	0.0033	302.31	0.0026	453.46	0.0033	604.61
12.0	2.0	0.0028	174.52	0.0017	349.03	0.0013	523.55	0.0017	698.07
	2.5	0.0044	218.15	0.0026	436.29	0.0021	654.44	0.0026	872.58
15.0	2.0	0.0021	275.42	0.0012	550.84	0.0010	826.26	0.0012	1101.68
	2.5	0.0032	344.28	0.0019	688.55	0.0015	1032.83	0.0019	1377.10

Flow velocity required to obtain a self-cleaning drain, waste, and vent plumbing system is 2.0 to 2.5 feet per second.

DESIGN AND ENGINEERING DATA

Cast Iron Installation

TABLE 2
Velocity and Flow in Cast Iron Soil Pipe Sewers and Drains
(Based on Manning's Formula with N = .012)

Pipe Size (In.)	SLOPE		¼ FULL		½ FULL		¾ FULL		FULL	
	(In./Ft.)	(Ft./Ft.)	Velocity (Ft./Sec.)	Flow (Gal./Min.)	Velocity (Ft./Sec.)	Flow (Gal./Min.)	Velocity (Ft./Sec.)	Flow (Gal./Min.)	Velocity (Ft./Sec.)	Flow (Gal./Min.)
2.0	0.0120	0.0010	0.36	0.83	0.46	2.16	0.52	3.67	0.46	4.35
	0.0240	0.0020	0.51	1.18	0.66	3.06	0.74	5.18	0.66	6.15
	0.0360	0.0030	0.62	1.45	0.80	3.75	0.90	6.35	0.80	7.53
	0.0480	0.0040	0.72	1.67	0.93	4.33	1.04	7.33	0.93	8.69
	0.0600	0.0050	0.80	1.87	1.04	4.84	1.16	8.20	1.04	9.72
	0.0720	0.0060	0.88	2.04	1.13	5.30	1.27	8.98	1.13	10.65
	0.0840	0.0070	0.95	2.21	1.23	5.72	1.38	9.70	1.23	11.50
	0.0960	0.0080	1.01	2.36	1.31	6.12	1.47	10.37	1.31	12.29
	0.1080	0.0090	1.07	2.50	1.39	6.49	1.56	11.00	1.39	13.04
	0.1200	0.0100	1.13	2.64	1.47	6.84	1.64	11.59	1.47	13.75
	0.2400	0.0200	1.60	3.73	2.07	9.67	2.33	16.39	2.07	19.44
	0.3600	0.0300	1.96	4.57	2.54	11.85	2.85	20.07	2.54	23.81
	0.4800	0.0400	2.26	5.28	2.93	13.68	3.29	23.18	2.93	27.49
	0.6000	0.0500	2.53	5.90	3.28	15.29	3.68	25.92	3.28	30.74
	0.7200	0.0600	2.77	6.47	3.59	16.75	4.03	28.39	3.59	33.67
	0.8400	0.0700	2.99	6.98	3.88	18.10	4.35	30.66	3.88	36.37
	0.9600	0.0800	3.20	7.47	4.14	19.35	4.65	32.78	4.14	38.88
1.0800	0.0900	3.39	7.92	4.40	20.52	4.93	34.77	4.40	41.24	
1.2000	0.1000	3.58	8.35	4.63	21.63	5.20	36.65	4.63	43.47	
3.0	0.0120	0.0010	0.47	2.55	0.61	6.56	0.69	11.05	0.61	13.12
	0.0240	0.0020	0.67	3.61	0.86	9.28	0.97	15.63	0.86	18.55
	0.0360	0.0030	0.82	4.42	1.06	11.36	1.19	19.14	1.06	22.72
	0.0480	0.0040	0.95	5.11	1.22	13.12	1.37	22.10	1.22	26.24
	0.0600	0.0050	1.06	5.71	1.37	14.67	1.53	24.71	1.37	29.33
	0.0720	0.0060	1.16	6.25	1.50	16.07	1.68	27.07	1.50	32.13
	0.0840	0.0070	1.25	6.75	1.62	17.35	1.81	29.24	1.62	34.71
	0.0960	0.0080	1.34	7.22	1.73	18.55	1.94	31.26	1.73	37.11
	0.1080	0.0090	1.42	7.66	1.83	19.68	2.06	33.16	1.83	39.36
	0.1200	0.0100	1.50	8.07	1.93	20.74	2.17	34.95	1.93	41.49
	0.2400	0.0200	2.21	11.42	2.73	29.33	3.07	49.43	2.73	58.67
	0.3600	0.0300	2.60	13.98	3.35	35.93	3.76	60.53	3.35	71.86
	0.4800	0.0400	3.00	16.14	3.87	41.49	4.34	69.90	3.87	82.97
	0.6000	0.0500	3.35	18.05	4.32	46.38	4.85	78.15	4.32	92.77
	0.7200	0.0600	3.67	19.77	4.74	50.81	5.31	85.61	4.74	101.62
	0.8400	0.0700	3.96	21.36	5.12	54.88	5.74	92.47	5.12	109.76
	0.9600	0.0800	4.24	22.83	5.47	58.67	6.13	98.85	5.47	117.34
1.0800	0.0900	4.50	24.22	5.80	62.23	6.51	104.85	5.80	124.46	
1.2000	0.1000	4.74	25.53	6.11	65.29	6.86	110.52	6.11	131.19	

DESIGN AND ENGINEERING DATA

Cast Iron Installation

TABLE 2 - (Continued)
Velocity and Flow in Cast Iron Soil Pipe Sewers and Drains
(Based on Manning's Formula with N = .012)

Pipe Size (In.)	SLOPE		¼ FULL		½ FULL		¾ FULL		FULL	
	(In./Ft.)	(Ft./Ft.)	Velocity (Ft./Sec.)	Flow (Gal./Min.)	Velocity (Ft./Sec.)	Flow (Gal./Min.)	Velocity (Ft./Sec.)	Flow (Gal./Min.)	Velocity (Ft./Sec.)	Flow (Gal./Min.)
4.0	0.0120	0.0010	0.57	5.45	0.74	14.08	0.83	23.63	0.74	28.12
	0.0240	0.0020	0.81	7.70	1.05	19.91	1.17	33.42	1.05	39.77
	0.0360	0.0030	0.99	9.44	1.28	24.38	1.44	40.92	1.28	48.71
	0.0480	0.0040	1.15	10.90	1.48	28.16	1.66	47.26	1.48	56.25
	0.0600	0.0050	1.28	12.18	1.65	31.48	1.85	52.83	1.65	62.88
	0.0720	0.0060	1.40	13.34	1.81	34.48	2.03	57.88	1.81	68.89
	0.0840	0.0070	1.51	14.41	1.96	37.25	2.19	62.51	1.96	74.41
	0.0960	0.0080	1.62	15.41	2.09	39.82	2.34	66.83	2.09	79.54
	0.1080	0.0090	1.72	16.34	2.22	42.23	2.49	70.88	2.22	84.37
	0.1200	0.0100	1.81	17.23	2.34	44.52	2.62	74.72	2.34	88.93
	0.2400	0.0200	2.56	24.36	3.31	62.96	3.71	105.67	3.31	125.77
	0.3600	0.0300	3.14	29.84	4.05	77.11	4.54	129.42	4.05	154.04
	0.4800	0.0400	3.62	34.46	4.68	89.04	5.24	149.44	4.68	177.86
	0.6000	0.0500	4.05	38.52	5.23	99.55	5.86	167.08	5.23	198.86
	0.7200	0.0600	4.43	42.20	5.73	109.05	6.42	183.02	5.73	217.84
	0.8400	0.0700	4.79	45.58	6.19	117.79	6.94	197.69	6.19	235.29
	0.9600	0.0800	5.12	48.73	6.62	125.92	7.41	211.34	6.62	251.54
1.0800	0.0900	5.43	51.68	7.02	133.56	7.86	224.15	7.02	266.80	
1.2000	0.1000	5.73	54.48	7.40	140.78	8.29	236.28	7.40	281.23	
5.0	0.0120	0.0010	0.67	9.94	0.86	25.71	0.96	43.15	0.86	51.37
	0.0240	0.0020	0.94	14.06	1.22	36.35	1.36	61.02	1.22	72.65
	0.0360	0.0030	1.15	17.22	1.49	44.52	1.67	74.74	1.49	88.98
	0.0480	0.0040	1.33	19.88	1.72	51.41	1.93	86.30	1.72	102.75
	0.0600	0.0050	1.49	22.23	1.92	57.48	2.15	96.49	1.92	114.87
	0.0720	0.0060	1.63	24.35	2.11	62.97	2.36	105.70	2.11	125.84
	0.0840	0.0070	1.76	26.30	2.28	68.01	2.55	114.17	2.28	135.92
	0.0960	0.0080	1.88	28.12	2.43	72.71	2.72	122.05	2.43	145.31
	0.1080	0.0090	2.00	29.82	2.58	77.12	2.89	129.45	2.58	154.12
	0.1200	0.0100	2.10	31.44	2.72	81.29	3.05	136.45	2.72	162.46
	0.2400	0.0200	2.97	44.46	3.85	114.96	4.31	192.97	3.85	229.75
	0.3600	0.0300	3.64	54.45	4.71	140.80	5.28	236.34	4.71	281.38
	0.4800	0.0400	4.21	62.88	5.44	162.58	6.09	272.91	5.44	324.91
	0.6000	0.0500	4.70	70.30	6.08	181.77	6.81	305.12	6.08	363.26
	0.7200	0.0600	5.15	77.01	6.66	199.12	7.46	334.24	6.66	397.94
	0.8400	0.0700	5.56	83.18	7.19	215.07	8.06	361.02	7.19	429.82
	0.9600	0.0800	5.95	88.92	7.69	229.92	8.62	385.95	7.69	459.50
1.0800	0.0900	6.31	94.31	8.16	243.92	9.14	409.36	8.16	487.37	
1.2000	0.1000	6.65	99.42	8.60	257.06	9.63	431.50	8.60	513.73	

DESIGN AND ENGINEERING DATA

TABLE 2 - (Continued)
Velocity and Flow in Cast Iron Soil Pipe Sewers and Drains
(Based on Manning's Formula with N = .012)

Pipe Size (In.)	SLOPE		¼ FULL		½ FULL		¾ FULL		FULL	
	(In./Ft.)	(Ft./Ft.)	Velocity (Ft./Sec.)	Flow (Gal./Min.)	Velocity (Ft./Sec.)	Flow (Gal./Min.)	Velocity (Ft./Sec.)	Flow (Gal./Min.)	Velocity (Ft./Sec.)	Flow (Gal./Min.)
6.0	0.0120	0.0010	0.75	16.23	0.97	41.98	1.09	70.55	0.97	83.96
	0.0240	0.0020	1.06	22.95	1.37	59.37	1.54	99.77	1.37	118.74
	0.0360	0.0030	1.30	28.11	1.68	72.71	1.89	122.20	1.68	145.42
	0.0480	0.0040	1.50	32.46	1.94	83.96	2.18	141.10	1.94	167.92
	0.0600	0.0050	1.68	36.29	2.17	93.87	2.44	157.76	2.17	187.74
	0.0720	0.0060	1.84	39.75	2.38	102.83	2.67	172.81	2.38	205.66
	0.0840	0.0070	1.99	42.94	2.57	111.07	2.88	186.66	2.57	222.13
	0.0960	0.0080	2.13	45.90	2.75	118.74	3.08	199.55	2.75	237.47
	0.1080	0.0090	2.26	48.69	2.92	125.94	3.27	211.65	2.92	251.88
	0.1200	0.0100	2.38	51.32	3.07	132.75	3.44	223.10	3.07	265.50
	0.2400	0.0200	3.36	72.58	4.35	187.74	4.87	315.51	4.35	375.47
	0.3600	0.0300	4.12	88.89	5.32	229.93	5.97	386.42	5.32	459.86
	0.4800	0.0400	4.75	102.64	6.15	265.50	6.89	446.20	6.15	531.00
	0.6000	0.0500	5.32	114.76	6.87	296.84	7.70	498.87	6.87	593.68
	0.7200	0.0600	5.82	125.71	7.53	325.17	8.44	546.27	7.53	650.34
	0.8400	0.0700	6.29	135.78	8.13	351.22	9.11	590.27	8.13	702.45
	0.9600	0.0800	6.72	145.16	8.70	375.47	9.74	631.02	8.70	750.95
1.0800	0.0900	7.13	153.96	9.22	398.25	10.33	669.30	9.22	796.50	
1.2000	0.1000	7.52	162.29	9.72	419.79	10.89	705.51	9.72	839.59	
8.0	0.0120	0.0010	0.91	35.25	1.18	91.04	1.32	153.06	1.18	182.09
	0.0240	0.0020	1.29	49.85	1.67	128.75	1.87	216.46	1.67	257.51
	0.0360	0.0030	1.58	61.05	2.04	157.69	2.29	265.11	2.04	315.38
	0.0480	0.0040	1.83	70.50	2.36	182.09	2.64	306.12	2.36	364.17
	0.0600	0.0050	2.04	78.82	2.64	203.58	2.96	342.26	2.64	407.16
	0.0720	0.0060	2.24	86.34	2.89	223.01	3.24	374.92	2.89	446.02
	0.0840	0.0070	2.42	93.26	3.12	240.88	3.50	404.96	3.12	481.75
	0.0960	0.0080	2.58	99.70	3.34	257.51	3.74	432.92	3.34	515.02
	0.1080	0.0090	2.74	105.75	3.54	273.13	3.97	459.18	3.54	546.26
	0.1200	0.0100	2.89	111.47	3.73	287.90	4.18	484.02	3.73	575.81
	0.2400	0.0200	4.08	157.64	5.28	407.16	5.91	684.51	5.28	814.32
	0.3600	0.0300	5.00	193.06	6.46	498.66	7.24	838.35	6.46	997.33
	0.4800	0.0400	5.78	222.93	7.46	575.81	8.36	968.05	7.46	1151.62
	0.6000	0.0500	6.46	249.24	8.34	643.77	9.35	1082.31	8.34	1287.55
	0.7200	0.0600	7.07	273.03	9.14	705.22	10.24	1185.61	9.14	1410.44
	0.8400	0.0700	7.64	294.91	9.87	761.72	11.06	1280.60	9.87	1523.45
	0.9600	0.0800	8.17	315.27	10.55	814.31	11.83	1369.02	10.55	1628.63
1.0800	0.0900	8.66	334.40	11.19	863.71	12.54	1452.07	11.19	1727.42	
1.2000	0.1000	9.13	352.4	11.80	910.43	13.22	1530.61	11.80	1820.86	

DESIGN AND ENGINEERING DATA

Cast Iron Installation

TABLE 2 - (Continued)
Velocity and Flow in Cast Iron Soil Pipe Sewers and Drains
(Based on Manning's Formula with N = .012)

Pipe Size (In.)	SLOPE		¼ FULL		½ FULL		¾ FULL		FULL	
	(In./Ft.)	(Ft./Ft.)	Velocity (Ft./Sec.)	Flow (Gal./Min.)	Velocity (Ft./Sec.)	Flow (Gal./Min.)	Velocity (Ft./Sec.)	Flow (Gal./Min.)	Velocity (Ft./Sec.)	Flow (Gal./Min.)
10.0	0.0120	0.0010	1.06	64.08	1.37	165.75	1.54	278.56	1.37	331.51
	0.0240	0.0020	1.50	90.62	1.94	234.41	2.17	393.95	1.94	468.83
	0.0360	0.0030	1.84	110.99	2.37	287.10	2.66	482.48	2.37	574.19
	0.0480	0.0040	2.12	128.16	2.74	331.51	3.07	557.12	2.74	663.02
	0.0600	0.0050	2.37	143.29	3.07	370.64	3.43	622.88	3.07	741.28
	0.0720	0.0060	2.60	156.96	3.36	406.01	3.76	682.33	3.36	812.03
	0.0840	0.0070	2.80	169.54	3.63	438.55	4.06	737.01	3.63	877.09
	0.0960	0.0080	3.00	181.24	3.88	468.82	4.34	787.89	3.88	937.65
	0.1080	0.0090	3.18	192.24	4.11	497.26	4.61	835.69	4.11	994.53
	0.1200	0.0100	3.35	202.64	4.33	524.16	4.86	880.89	4.33	1048.32
	0.2400	0.0200	4.74	286.57	6.13	741.28	6.87	1245.77	6.13	1482.55
	0.3600	0.0300	5.80	350.98	7.51	907.88	8.41	1525.75	7.51	1815.75
	0.4800	0.0400	6.70	405.27	8.67	1048.32	9.71	1761.78	8.67	2096.65
	0.6000	0.0500	7.49	453.11	9.69	1172.06	10.86	1969.73	9.69	2344.13
	0.7200	0.0600	8.21	496.36	10.62	1283.93	11.90	2157.74	10.62	2567.86
	0.8400	0.0700	8.87	536.12	11.47	1386.80	12.85	2330.62	11.47	2773.61
	0.9600	0.0800	9.48	573.14	12.26	1482.55	13.74	2491.54	12.26	2965.11
1.0800	0.0900	10.05	607.91	13.00	1572.49	14.57	2642.67	13.00	3144.97	
1.2000	0.1000	10.60	640.79	13.71	1657.55	15.36	2785.62	13.71	3315.09	
12.0	0.0120	0.0010	1.20	104.53	1.55	270.34	1.74	454.27	1.55	540.68
	0.0240	0.0020	1.69	147.83	2.19	382.32	2.45	642.43	2.19	764.63
	0.0360	0.0030	2.07	181.05	2.68	468.24	3.01	786.82	2.68	936.48
	0.0480	0.0040	2.40	209.06	3.10	540.68	3.47	908.54	3.10	1081.35
	0.0600	0.0050	2.68	233.74	3.46	604.49	3.88	1015.78	3.46	1208.99
	0.0720	0.0060	2.93	256.05	3.79	662.19	4.25	1112.73	3.79	1324.38
	0.0840	0.0070	3.17	276.56	4.10	715.25	4.59	1201.88	4.10	1430.50
	0.0960	0.0080	3.39	295.66	4.38	764.63	4.91	1284.87	4.38	1529.27
	0.1080	0.0090	3.59	313.59	4.65	811.01	5.21	1362.81	4.65	1622.03
	0.1200	0.0100	3.79	330.56	4.90	854.88	5.49	1436.53	4.90	1709.77
	0.2400	0.0200	5.36	467.48	6.93	1208.99	7.76	2031.55	6.93	2417.98
	0.3600	0.0300	6.56	572.54	8.48	1480.71	9.50	2488.14	8.48	2961.41
	0.4800	0.0400	7.58	661.11	9.80	1709.77	10.98	2873.05	9.80	3419.54
	0.6000	0.0500	8.47	739.14	10.95	1911.58	12.27	3212.17	10.95	3823.17
	0.7200	0.0600	9.28	809.69	12.00	2094.03	13.44	3518.76	12.00	4188.07
	0.8400	0.0700	10.02	874.57	12.96	2261.81	14.52	3800.69	12.96	4523.63
	0.9600	0.0800	10.71	934.95	13.86	2417.98	15.52	4063.11	13.86	4835.96
1.0800	0.0900	11.36	991.67	14.70	2564.65	16.46	4309.57	14.70	5129.30	
1.2000	0.1000	11.98	1045.31	15.49	2703.38	17.35	4542.69	15.49	5406.76	

DESIGN AND ENGINEERING DATA

Cast Iron Installation

TABLE 2 - (Continued)
Velocity and Flow in Cast Iron Soil Pipe Sewers and Drains
(Based on Manning's Formula with N = .012)

Pipe Size (In.)	SLOPE		¼ FULL		½ FULL		¾ FULL		FULL	
	(In./Ft.)	(Ft./Ft.)	Velocity (Ft./Sec.)	Flow (Gal./Min.)	Velocity (Ft./Sec.)	Flow (Gal./Min.)	Velocity (Ft./Sec.)	Flow (Gal./Min.)	Velocity (Ft./Sec.)	Flow (Gal./Min.)
15.0	0.0120	0.0010	1.39	192.03	1.80	496.67	2.02	834.85	1.80	993.34
	0.0240	0.0020	1.97	271.58	2.55	702.40	2.86	1180.65	2.55	1404.79
	0.0360	0.0030	2.42	332.61	3.12	860.25	3.50	1445.99	3.12	1720.51
	0.0480	0.0040	2.79	384.07	3.61	993.34	4.04	1669.69	3.61	1986.67
	0.0600	0.0050	3.12	429.40	4.03	1110.58	4.52	1866.77	4.03	2221.17
	0.0720	0.0060	3.42	470.38	4.42	1216.58	4.95	2044.95	4.42	2433.17
	0.0840	0.0070	3.69	508.07	4.77	1314.06	5.35	2208.79	4.77	2628.12
	0.0960	0.0080	3.94	543.15	5.10	1404.79	5.72	2361.30	5.10	2809.58
	0.1080	0.0090	4.18	576.10	5.41	1490.01	6.06	2504.54	5.41	2980.01
	0.1200	0.0100	4.41	607.26	5.70	1570.60	6.39	2640.01	5.70	3141.21
	0.2400	0.0200	6.24	858.80	8.06	2221.17	9.04	3733.54	8.06	4442.34
	0.3600	0.0300	7.64	1051.81	9.88	2720.37	11.07	4572.64	9.88	5440.73
	0.4800	0.0400	8.82	1214.52	11.41	3141.21	12.78	5280.03	11.41	6282.41
	0.6000	0.0500	9.86	1357.88	12.75	3511.98	14.29	5903.25	12.75	7023.95
	0.7200	0.0600	10.80	1487.48	13.97	3847.18	15.65	6466.69	13.97	7694.35
	0.8400	0.0700	11.67	1606.66	15.09	4155.43	16.91	6984.82	15.09	8310.85
	0.9600	0.0800	12.47	1717.60	16.13	4442.33	18.07	7467.07	16.13	8884.66
	1.0800	0.0900	13.23	1821.78	17.11	4711.80	19.17	7920.03	17.11	9423.61
	1.2000	0.1000	13.94	1920.33	18.03	4966.68	20.21	8348.44	18.03	9933.35

SUPPORT SPACING AND HANGERS

NOTE: The following information provides general guidelines. It should be used only as a reference and not as a guarantee of performance. Specific installation instructions and techniques may be required as a result of local plumbing and building codes, engineering specifications and instructions.

NOTICE

Failure to properly support or hang cast iron pipe could result in system failure and/or property damage.

Cast iron soil pipe installed in the horizontal position shall be supported at every hub (hub and spigot) or every coupling (hubless). The hanger shall be placed within 18" of the hub or coupling. Joints used for connecting cast iron soil pipe possess sufficient shear strength to require one hanger per joint or hub.

Installations requiring multiple joints within a four-foot developed length shall be supported at every other or alternating hub or coupling.

Vertical components shall be secured at each stack base and at sufficiently close intervals to keep the system in alignment and to adequately support the pipe and its contents. Riser clamps, sometimes called floor or friction clamps, are required for vertical piping in multi-story structures in order for each floor not to exceed 15 feet.

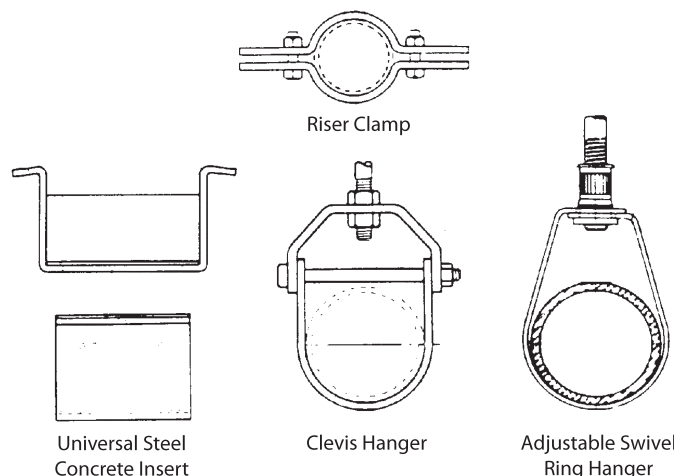

- **Vertical Piping** – Secure vertical piping at sufficiently close intervals to keep the pipe in alignment and to support the weight of the pipe and its contents.

Support stacks at their bases and at sufficient floor intervals to meet the requirements of local codes. Approved metal clamps or hangers should be used for this purpose.

- **Horizontal Piping** – Support horizontal pipe and fittings at sufficiently close intervals to maintain alignment and prevent sagging or grade reversal. Support each length of pipe by an approved hanger located not more than 18" from the joint. Support terminal ends of all horizontal runs or branches and each change of direction or alignment with an approved hanger.

FIRE RESISTANCE OF CAST IRON SYSTEMS

When it comes to fire-resistive construction and material selection, cast iron soil pipe systems offer a piping product that is non-combustible. Cast iron soil pipe and fittings will not burn in the event of a building fire. Many building codes require that newly constructed buildings be built with fire compartments and separations; these separations or compartments help reduce the spread of fire and smoke within a building in the event of a fire. In a fire-resistive constructed building, the compartments may be penetrated with pipe or other service penetration. Those penetrations must be sealed back to the original fire integrity of the compartment with a material or product that seals the annular space around the penetration to stop the spread of flame and smoke.

Because cast iron soil pipe is considered a non-combustible material, it is also a perfect choice to use in return-air plenums for DWV applications.

WARNING

To help ensure adequate fire-resistance, always refer to the fire-stop system manufacturer's safety information and recommendations.

Note: This manual is not a complete engineering reference addressing all aspects of design and installation of a drain, waste and vent or sanitary storm system.

Reference Standards Cast Iron

AMERICAN SOCIETY FOR TESTING AND MATERIALS

ASTM	TITLE
A 74	SPECIFICATION FOR CAST IRON SOIL PIPE AND FITTINGS HUB AND SPIGOT (SERVICE AND EXTRA HEAVY)
SCOPE:	THIS SPECIFICATION COVERS CAST IRON PIPE AND FITTINGS USED IN SANITARY DRAIN, WASTE, AND VENT (DWV), SEWER, AND STORM DRAINAGE APPLICATION. THIS SYSTEM IS INTENDED FOR USE IN NONPRESSURE APPLICATIONS.
C 564	SPECIFICATION FOR RUBBER GASKETS FOR CAST IRON SOIL PIPE AND FITTINGS
SCOPE:	THIS SPECIFICATION COVERS PREFORMED RUBBER GASKETS USED TO SEAL JOINTS IN CAST IRON SOIL PIPE AND FITTINGS.
C 1277	SPECIFICATION FOR COUPLING FOR USE IN CONNECTION WITH HUBLESS CAST IRON PIPE AND FITTINGS FOR SANITARY AND STORM DRAIN, WASTE, AND VENT PIPING APPLICATION (REGULAR HUBLESS COUPLING)
SCOPE:	THE PURPOSE OF THIS SPECIFICATION IS TO ESTABLISH CRITERIA FOR MATERIAL DIMENSIONS AND TOLERANCES FOR ONE TYPE OF COUPLING USED IN HUBLESS CAST IRON SOIL PIPE AND FITTING FOR SANITARY AND STORM DRAIN, WASTE AND VENT PIPING APPLICATIONS.
C 1540	SPECIFICATION FOR SHIELDED COUPLINGS JOINING HUBLESS CAST IRON SOIL PIPE AND FITTINGS (HEAVY DUTY COUPLINGS)
SCOPE:	THIS SPECIFICATION COVERS THE EVALUATION OF THE PERFORMANCE OF SHIELDED HUBLESS COUPLINGS TO JOIN CAST IRON SOIL PIPE AND FITTINGS.

CAST IRON SOIL PIPE INSTITUTE

CISPI	TITLE
301	SPECIFICATION FOR HUBLESS CAST IRON SOIL PIPE AND FITTINGS FOR SANITARY AND STORM DRAIN, WASTE, AND VENT PIPING APPLICATIONS
SCOPE:	THE PURPOSE OF THIS STANDARD IS TO ESTABLISH STANDARDS COVERING MATERIAL, DIMENSIONS, AND TOLERANCE FOR PIPE AND FITTINGS FOR HUBLESS CAST IRON SANITARY AND STORM DRAIN, SANITARY WASTE, AND VENT PIPING APPLICATIONS.
310	SPECIFICATION FOR COUPLING FOR USE IN CONNECTION WITH HUBLESS CAST IRON PIPE AND FITTINGS FOR SANITARY AND STORM DRAIN, WASTE, AND VENT PIPING APPLICATION (REGULAR HUBLESS COUPLING)
SCOPE:	THE PURPOSE OF THIS SPECIFICATION IS TO ESTABLISH CRITERIA FOR MATERIAL DIMENSIONS AND TOLERANCES FOR ONE TYPE OF COUPLING USED IN HUBLESS CAST IRON SOIL PIPE AND FITTING FOR SANITARY AND STORM DRAIN, WASTE AND VENT PIPING APPLICATIONS.

INSTALLATION PROCEDURES FOR CAST IRON

Cast Iron Installation

WARNING

Failure to follow proper installation practices, procedures, or techniques may result in personal injury, system failure or property damage.

- Always use protective equipment including eye protection and safety clothing while installing or cutting pipe.
- Power equipment can be dangerous if used improperly. Always review and carefully follow the manufacturer's operating and safety instructions.

Employ the knowledge and skill of an expert, licensed plumbing contractor for the best possible installations. Follow good plumbing practices and observe all safety precautions. Cast iron soil pipe and fittings should be installed in accordance with all applicable local plumbing codes and regulations. Equally important, follow all appropriate engineering specifications, building regulations and manufacturers' instructions.

NOTE: The following information is intended for use by licensed plumbing contractors and contains only suggested installation and testing procedures. The information is not meant to be a complete form of instruction.

Always take care during the installation of drain, waste and vent (DWV) systems to assure their satisfactory performance. **WARNING:** Failure to follow proper installation practices, procedures, and techniques can result in system failure, property damage, or personal injury. Please read all of the following information.

WARNING

To reduce the risk of serious or fatal injury to the operator and/or bystanders:

- Always read and follow the machine/tool manufacturer's instructions.
- Always secure pipe before cutting so that it cannot roll, drop or slip.

CUTTING METHODS FOR CAST IRON SOIL PIPE

There are several methods of cutting cast iron soil pipe. They may be grouped into two basic categories: those that require external power for their operation and those that require only hand operation. Methods that require external

power are used primarily in fabrication work or high-volume cutting operations. Examples of this type of equipment include the abrasive saw (sometimes called a chop saw), the power hack saw, and the electrically actuated hydraulic snap cutter. The abrasive saw is an efficient tool for cutting 8" and larger pipe.

There are two types of hand-powered cutting tools used in the industry today: the standard steel pipe cutter uses cutting wheels designed specifically to cut cast iron soil pipe; the snap cutter is used more commonly to cut cast iron soil pipe in the field. Several types of snap cutters are available.

Cutting Cast Iron Soil Pipe with a Snap Cutter

1. Read and follow instructions from manufacturer of the snap cutter.
2. Measure the required pipe length and mark it for the cut.



3. Position the snap cutter's chain squarely around the pipe to assure that the cut is straight. Set the chain so that the maximum number of cutting wheels come into contact with the pipe.



4. Score the pipe by applying pressure on the handles, which causes the cutting wheels to indent the pipe's

INSTALLATION PROCEDURES FOR CAST IRON

surface. Scoring the pipe prior to the actual cut is the key to making a straight, clean cut. If a piece of pipe is unusually tough, score it several times before making the final cut.

5. Rotate the pipe a few degrees within the chain. Then apply quick final pressure with the handles to complete the cut.

JOINING METHODS FOR CAST IRON

SOIL PIPE

There are generally three methods for joining cast iron soil pipe. A compression gasket or caulked joint can be used to join hub and spigot, while a hubless coupling may be used to join hubless cast iron.



Compression Gaskets

A compression gasket is a molded one-piece gasket made of an elastomer that meets ASTM C 564. The physical characteristics of this elastomer help to insure that the gasket will not decay or deteriorate from contact with materials carried in the piping system, or from contact with the soil or air around the pipe.

NOTICE

To reduce the risk of property damage, service compression gaskets must only be used with service pipe, while extra heavy compression gaskets must only be used with extra heavy pipe.

Charlotte Pipe and Foundry Company strongly recommends that its cast iron hub and spigot pipe and fittings be joined with compression gaskets sold by our Company. Our hub and spigot pipe and fittings are manufactured to very specific manufacturing tolerances which conform to ASTM A 74. Our gaskets, produced in conformity with ASTM C 564, are especially designed to work with our pipe and fitting tolerances.

It has been the experience of our Company that gaskets designed by other manufacturers, even though they may be manufactured to the same consensus standards, may give less than satisfactory test and performance results. Consequently, failures in installations using gaskets not

recommended by Charlotte Pipe® are not the responsibility of this company.

WARNING

Follow all safety procedures in this manual and use protective eye wear, clothing and equipment when making any compression gasket joint to reduce the risk of serious injury.

Neoprene is well known for its low degree of permanent deformation (or compression set), even under heavy loading for long periods of time. Properly compounded neoprene gaskets not only provide a positive seal, but will retain this sealing capacity for many years.

Neoprene is one of the few elastomers that is well suited to direct burial because it will withstand the natural corrosive components of soil, as well as sanitary effluent.

Although all rubber materials, including neoprene, tend to stiffen at low temperatures, neoprene gaskets are readily installed in winter weather. Charlotte® compression gaskets will perform best if kept above 50°F. To make joining easy in cold conditions, keep gaskets in warm water until ready to use.

WARNING

Testing with or use of compressed air or gas in Cast Iron pipe or fittings can result in explosive failures and cause severe injury or death.

AIR/GAS



- NEVER test with or transport/store compressed air or gas in Cast Iron pipe or fittings.
- NEVER test Cast Iron pipe or fittings with compressed air or gas.
- ONLY use Cast Iron pipe and fittings for drain, waste and vent or sanitary sewer applications.

WARNING: The maximum working temperature for neoprene gaskets is 212°F, with a maximum working pressure of (0) zero Psi. Therefore, the Charlotte Seal and Quick-tite gaskets are not rated for pressure applications.

Joint deflection using a compression gasket has a maximum limit of up to 5 degrees. Maximum deflection should not exceed 1/2 inch per foot of pipe. This would allow 5 inches of deflection for a 10 foot piece of pipe and 2-1/2" for a 5 foot piece of pipe. Installation should initially be completed in a straight line and then deflected to the appropriate amount. This helps assure a good tight joint. For more than 5 degrees of deflection, fittings should be used.

INSTALLATION PROCEDURES FOR CAST IRON

Making A Compression-Gasket Joint

1. Clean the hub and spigot so they are free of all dirt, mud, sand, gravel, and other foreign materials.
2. Remove sharp edges by filing or tapping with a ball-peen hammer. Insert the gasket into the hub. This may be done by using one of three methods.



- **Double Folding:** Squeeze the gasket together with both hands, then insert it into the hub. As you withdraw your hands, the gasket will unfold and snap into proper position.



- **Thumb Fold:** Hold the outside circumference of the gasket and press thumbs down and in, as though turning the gasket inside out. Place the gasket into the hub and release it, allowing it to snap into proper position.



- **Drive-In:** Place the gasket into the hub as far as possible, then tap the gasket's outer lip with a rubber mallet or flat board until it becomes seated. This method works best on two- or three-inch gaskets.
3. Regardless of which insertion method you use, the gasket must be completely inserted into the hub. Only the gasket's flange that shows identification information should remain exposed outside the hub.

! WARNING

To reduce the risk of serious injury:

- Keep pipe joint and adhesive lubricant from touching eyes or skin.
- Only use adhesive lubricant with proper ventilation.
- Read and carefully follow the manufacturer's application and safety instructions, particularly when working around sources of heat, sparks or open flame.
- In case of an accident, follow hazardous warning and medical treatment statement shown on the product's label.

4. Lubricate the gasket following the pipe joint lubrication manufacturer's recommendations. For small-diameter pipe and fittings (2" - 4"), coat the inside of the gasket with lubricant using a paint brush or rag, and then coat the outside of the spigot.

INSTALLATION PROCEDURES FOR CAST IRON



Installing Fittings with Compression-Gasket Joints

There are several techniques that may be used to assemble fitting compression-gasket joints. Review the following suggestions to determine which best suits your needs.

! WARNING

Follow all safety procedures in this manual and use protective eye wear, clothing and equipment when making any compression gasket joint to reduce the risk of serious injury.

For large-diameter pipe and fittings (5" - 15"), we recommend that an adhesive lubricant be used to ensure a water-tight seal. Adhesive lubricants should be applied to the inside of the gasket, the outside of the spigot and the inside of the hub.



NOTICE

To reduce the risk of joint leaks and property damage with cast iron pipe and fittings in sizes 5" and larger, adhesive lubricant should be applied to the inside of the gasket, the outside of the spigot and the inside of the hub. The use of adhesive lubricant is not a substitute for proper joint restraint.

5. Align the pipe so that it is straight, then push or pull the spigot through all the sealing rings of the gasket. Charlotte plain-end pipe is manufactured with beveled ends to make insertion easy. As the spigot barrel is forced into the gasket, the gasket is compressed and completely seals the joint in both displacement and compression. When seated correctly, you will feel the spigot end of the pipe "bottom" in the hub.

- **Using a Lead Maul:** Almost all plain-end fittings may be installed by driving them into place with a lead maul or a mallet. After installing and lubricating the gasket, align the spigot and strike the fitting on its driving lug, or across its full hub, with a lead maul. Driving lugs are standard on all Charlotte plain-end bends and they make joining easy. The fitting may be struck as hard as necessary, since the lead maul will deform before damaging the fitting.

INSTALLATION PROCEDURES FOR CAST IRON

Cast Iron Installation



- **Using a Mallet:** If you prefer to use a mallet, place a wooden block over the fitting's hub. After installing and lubricating the gasket, align the spigot and carefully strike the wooden block with the mallet until the spigot is properly seated.
- **Joining by Jolting:** Pre-assembly of fittings and short lengths of pipe can be done by jolting on a piece of wood or other sturdy surface. After installing and lubricating the gasket, align the spigot in the gasket, then push or pull the spigot into the gasket as far as you can. Next, jolt the assembly on a piece of wood or other sturdy surface until the spigot "bottoms" in the hub.
- **Using a Pry-bar:** A pry-bar can speed installations, particularly on long runs of straight pipe being installed below ground. After installing and lubricating the gasket, align the spigot in the gasket, then apply the pry-bar to force the pipe through seal. It is correctly seated when it "bottoms" in the hub.
- **Making Adjustments:** You can reposition a fitting's alignment after forming a compression-gasket joint.

- **Cold Weather Installations:** All elastomers tend to stiffen as the ambient temperature drops. Charlotte® compression gaskets will perform best if kept above 50 degrees F. To make joining easy in cold conditions, keep gaskets in warm water until ready for use. Cold gaskets that have become stiff can quickly be made pliable by bringing them into a heated space or immersing them in warm water.

Important Reminders and Helpful Hints about Compression Gasket Joints

- Use only Charlotte® Service or Extra Heavy pipe and fittings with Charlotte compression gaskets.
- Service pipe and fittings must be joined with Service gaskets. Extra Heavy pipe and fittings must be joined with Extra Heavy gaskets.
- Before inserting the gasket, make sure that the hub is clear of all dirt and other foreign materials that would interfere with assembly.
- Lubricate the inside of the gasket and the outside of the spigot.
- When installing large-diameter pipe (5" - 15"), we recommend using adhesive-type lubricant.
- Make certain that the pipe or fitting is in good alignment (not cocked) before pulling the plain-end spigot into the gasket.
- The spigot must pass through both seals until it "bottoms" firmly in the base of the hub.
- If pipe is cut in the field and you are having difficulty making it bottom out, you may be snagging the gasket with the pipe's cut end. To solve this problem, smooth the sharp spigot by filing.
- To make joining easy in cold conditions, keep gaskets in warm water until ready for use.
- **NOTICE:** If adhesive lubricant has been used and allowed to set, repositioning the pipe or fitting will damage the adhesive bond.

NOTICE

Turning the fitting does not damage Charlotte compression gaskets when non-adhesive lubricant has been correctly used. However, if adhesive lubricant has been used and allowed to set, repositioning the fitting will damage the adhesive bond.

INSTALLATION PROCEDURES FOR CAST IRON

A caulked joint may also be used to join hub and spigot cast iron soil pipe, as follows:

1. Place the spigot end of a pipe or fitting inside the hub of another pipe or fitting and align correctly, making sure that all surfaces are clean and dry.
2. Place oakum into the joint using a yarning iron.
3. Pack the oakum to the proper depth using a packing iron.
4. Pour molten lead into the joint, filling it to the top of the hub. For a horizontal joint, use a joint runner to retain the molten lead in the hub.

! WARNING

To reduce the risk of serious or fatal injury from explosions or burns, use caution when handling molten lead.

- Never allow molten lead to contact liquids including water, because it may explode.
- Molten lead is extremely hot and handling can be dangerous.
- Always utilize protective eye wear, safety clothing and equipment when making a caulked joint.

5. After the lead has cooled somewhat and solidified, the joint is ready to be caulked. Caulk the joint with inside and outside caulking irons. Caulking the joint sets the lead and makes a leak-free joint.

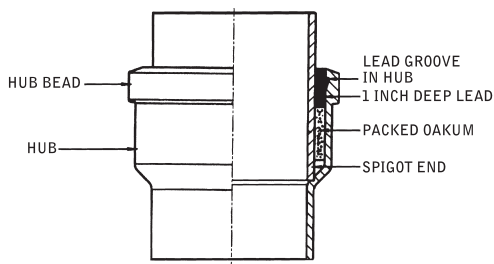

HUBLESS JOINTS

The shielded coupling for hubless cast iron soil pipe and fittings provides a more compact installation without sacrificing the quality and performance of cast iron. The hubless coupling system typically uses a one-piece neoprene gasket and a shield of stainless steel retaining clamps. The great advantage of the system is that it permits joints to be made in limited-access areas. The 300 series stainless steel, which is always used with hubless couplings, was selected because of its superior corrosion resistance. It is resistant to oxidation, warping and deformation, offers rigidity under tension with

substantial tension strength, and still provides sufficient flexibility.

The neoprene gasket absorbs shock and vibration, and helps eliminate galvanic action between the cast iron and the stainless steel shield. The neoprene sleeve is protected by a non-combustible stainless steel sleeve. Joint deflection using a shielded hubless coupling has a maximum limit of up to 5 degrees. Maximum deflection should not exceed 1/2 inch per foot of pipe. This would allow 5 inches of deflection for a 10 foot piece of pipe. Installation should initially be completed in a straight line and then deflected to the appropriate amount. This helps assure a good tight joint. For more than 5 degrees of deflection, fittings should be used.

Hubless couplings are used to connect cast iron pipe and fittings. The couplings are composed of a stainless-steel shield, clamp assembly and an elastomeric sealing sleeve made of neoprene. It is important to note that hubless couplings are manufactured to CISPI 310 and ASTM C 1277, while the heavy duty couplings are manufactured to ASTM C 1540.

NOTE: In hubless cast iron installations, Charlotte Pipe's warranty will not apply if products are joined with unshielded hubless couplings. Charlotte Pipe requires that its hubless cast iron pipe and fittings be joined only with shielded hubless couplings manufactured in accordance with CISPI 310, ASTM C 1277 and certified by NSF® International or with Heavy Duty Couplings meeting ASTM C 1540. Failures in installations using couplings not recommended by Charlotte Pipe or not conforming to CISPI 310, ASTM C 1277 or ASTM C 1540 are not the responsibility of this company.

Horizontal pipe and fittings five (5) inches and larger must be suitably braced to prevent horizontal movement. This must be done at every branch opening or change

! WARNING

Horizontal pipe and fittings five (5) inches and larger must be suitably braced to prevent horizontal movement. This must be done at every branch opening or change in direction by the use of a brace, block, rodding or other suitable method, to prevent movement or joint separation. Heavy Duty or wide body couplings are not a substitute for proper thrust restraint. Failure to properly restrain branch openings or changes in direction will result in joint movement or separation, causing system failure and potential serious injury.

INSTALLATION PROCEDURES FOR CAST IRON

in direction by the use of a brace, block, rodding or other suitable method, to prevent movement or joint separation.

A heavy duty hubless coupling should only be used when a more rigid joint is needed. Heavy duty couplings provide additional sealing clamps. However, heavy duty couplings are not a substitute for proper thrust restraints. The dimensions specified in ASTM C 1540 result in couplings that extend beyond the "W" dimension of the hubless pipe fittings in 1-1/2" through 6" diameters. Therefore, ASTM C 1540 (heavy duty) couplings will extend beyond the gasket positioning lug and may also cover raised lettering on some fittings.

Both regular and heavy duty couplings are to be installed using a torque wrench. Regular hubless couplings are typically tightened with a preset torque wrench set to 60-inch pounds, while heavy duty couplings are typically tightened with a preset torque wrench set to 80-inch pounds. The tightening sequence is essential when installing both regular and heavy duty couplings. Torque settings and sequencing vary by coupling manufacturer. Couplings must be installed per the requirements of the coupling manufacturer.

! WARNING

Hubless couplings are not rated for pressure.

! WARNING

Failure to follow proper installation practices, procedures, or techniques may result in personal injury, system failure or property damage.

- Always use protective equipment including eye protection and safety clothing while installing or cutting pipe.
- Power equipment can be dangerous if used improperly. Always review and carefully follow the manufacturer's operating and safety instructions.

Making Hubless Joints

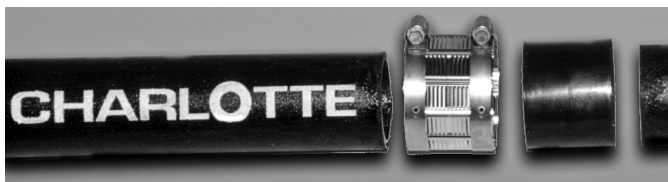

1. Lay out components as shown. Pipe ends are to be cut as squarely and smoothly as possible. Check coupling and gasket for foreign material, clean if necessary.

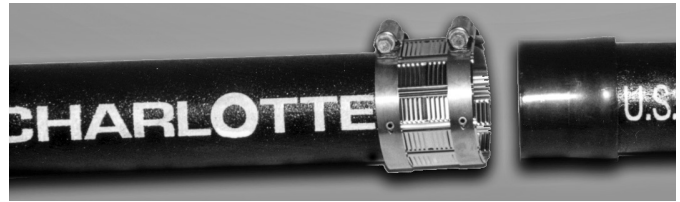

2. Insert gasket over pipe or fitting until end of pipe or fitting butts against the gasket's integrally molded shoulder. Slide the coupling assembly over the other pipe or fitting to be joined.



3. Insert the second pipe or fitting into the gasket until both ends of pipe or fittings butt against the integrally molded shoulder in the center of gasket.



4. Slide the coupling assembly into position centered over gasket. At this point, it is recommended to hand tighten all the clamps in the coupling assembly with a wrench.

Standard Duty Couplings

- Coupling sizes 1 1/2", 2", 3" and 4" have two clamps. Use a preset, or dial indicating type torque wrench and tighten to 60 inch pounds of torque. Tighten clamp 1 and then clamp 2 alternately in 20 lbf-in increments until the recommended 60 lbf-in is reached.

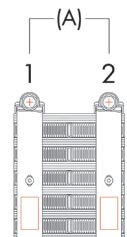

INSTALLATION PROCEDURES FOR CAST IRON

- Coupling sizes 5", 6", 8", and 10" have four clamps. Use a preset, or dial indicating type torque wrench and tighten to 60 inch pounds of torque. First, the inner clamps "A" are to be tightened alternately in 20 lbf-in increments until the recommended 60 lbf-in load is reached. Next, the outside clamps "B" are to be tightened alternately in 20 lbf-in increments until the recommended 60 lbf-in is reached.

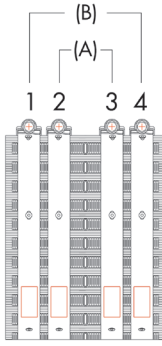

Note: When O.D. difference between pipe and fitting is visibly different the following torque pattern is recommended; 1-3 and 2-4.

- Coupling sizes 12" and 15" have six clamps. Use a preset, or dial indicating type torque wrench and tighten clamps to 120 inch-pounds of torque. First, the inner clamps "A" are to be tightened alternately in 20 lbf-in increments until the recommended 120 lbf-in is reached. Next, the middle clamps "B" are to be tightened alternately in 20 lbf-in increments until the recommended 120 lbf-in is reached. Finally, the outer clamps "C" are to be tightened alternately in 20 lbf-in increments until the recommended 120 lbf-in is reached.

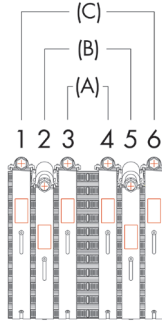

Note: When O.D. difference between pipe and fitting is visibly different the following pattern is recommended; 1-4, 2-5, and 3-6.

Heavy Duty "HD" and "MD" Couplings

- Coupling sizes 1½", 2", 3", and 4" have four clamps. Use a preset, or dial indicating type torque wrench and tighten to 80 inch pounds of torque. First, the inner clamps "A" are to be tightened alternately in 20 lbf-in increments until the recommended 80 lbf-in is reached. Then, the outer clamps "B" are tightened alternately in 20 lbf-in increments until the recommended 80 lbf-in is reached.



Note: When the O.D. difference between pipe and fitting is visibly different the following torque pattern is recommended; 1-3 and 2-4.

Coupling sizes 5", 6", 8" and 10" have six clamps. Use a preset, or dial indicating type torque wrench and tighten to 80 inch pounds of torque. First, the inner clamps "A" are to be tightened alternately in 20 lbf-in increments until the recommended 80 lbf-in

is reached. Next, the middle clamps "B" are to be tightened alternately in 20 lbf-in increments until the recommended 80 lbf-in is reached. Finally, the outer "C" clamps are to be tightened alternately in 20 lbf-in increments until the recommended 80 lbf-in is reached.

Note: When the O.D. difference between pipe and fitting is visibly different the following torque pattern is recommended; 1-4, 2-5, and 3-6.

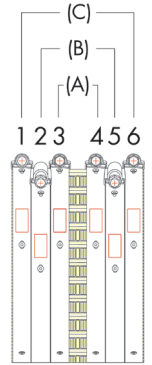

Note: Charlotte Pipe does not recommend or warrant installations joined with un-shielded hubless couplings.

- Charlotte Pipe requires that its hubless cast iron pipe and fittings be joined only with shielded hubless couplings manufactured in accordance with CISPI 310, ASTM C 1277 and certified by NSF® International or with Heavy Duty Couplings meeting ASTM C 1540.
- Failures in installations using couplings not recommended by Charlotte Pipe or not conforming to CISPI 310, ASTM C 1277 or ASTM C 1540 are not the responsibility of the company. For more information please see our Limited Warranty in this manual, call 800-438-6091 or visit www.charlottepipe.com.

UNDERGROUND INSTALLATION PROCEDURES

The physical properties of cast iron soil pipe and fittings make cast iron an ideal drain, waste, and vent material for underground installations. Two key elements for proper underground installations are trench preparation and backfilling.

The trench should be wide enough for easy assembly of the joints. Total load on the pipe includes both earth load and live load. Safety procedures including OSHA and other laws applicable to trenching should be observed, including provisions to avoid collapse of the trench wall. Cast iron, being a rigid material, does not depend upon sidefill for support. The trench bottom should be stable enough to support the complete barrel of the pipe. If possible, the barrel of the pipe should rest on even and undisturbed soil. Holes should be provided at each joint for each hub or coupling to allow for continuous support of the barrel along the trench bottom. If the ditch must be excavated deeper than the depth of the drainage pipe, place and tamp backfill material to provide uniform support for the pipe barrel.

Many times in the installation of underground cast iron,

INSTALLATION PROCEDURES FOR CAST IRON

It is necessary to make adjustments to the direction of the drain line. Cast iron soil pipe and neoprene compression gaskets will allow this through deflection in the joints. Installation should initially be completed in a straight line and then deflected to the appropriate amount. Maximum deflection should not exceed 1/2 inch per foot of pipe. This would allow 5 inches of deflection for a 10 foot piece of pipe. For changes in direction greater than these deflections, an appropriate fitting should be used.

While backfilling, use cradling and partial backfilling of pipe to stabilize its position and maintain its correct alignment. While pouring slabs, stabilize piping securely to prevent any misalignment during the pour. Firmly secure all closet bends installed under a slab.

Where unstable soil requires the drain and waste line to be supported with hangers attached to the concrete slab, sway bracing should always be a part of the support system. Sway bracing will help keep the system in proper alignment and help eliminate movement from side to side.

Once the underground installation is completed, the section is ready for testing. Charlotte Pipe recommends testing at 10 feet of hydrostatic (water) pressure (4.3 pounds per square inch.) See the Testing and Inspection section of this manual for more information. Because underground drainage pipe is usually the largest diameter pipe, it is necessary to restrain the system or joints from movement at changes in direction and end of runs prior to testing. This may be done by partially backfilling and leaving the joints exposed for inspection or rodding and or bracing.

! WARNING

Testing with or use of compressed air or gas in Cast Iron pipe or fittings can result in explosive failures and cause severe injury or death.

AIR/GAS



- NEVER test with or transport/store compressed air or gas in Cast Iron pipe or fittings.
- NEVER test Cast Iron pipe or fittings with compressed air or gas.
- ONLY use Cast Iron pipe and fittings for drain, waste and vent or sanitary sewer applications.

After testing is completed, the trench can be properly backfilled. When backfilling, care should be taken to protect the pipe from large rocks, stones, or frozen fill material that could damage the pipe. Cast iron soil pipe laid on a solid trench bottom does not require special backfilling or procedures.

Installers should always consider local conditions, codes, manufacturers' instructions, and engineers' instructions in any installation.

NOTE: This manual is not a complete engineering reference addressing all aspects of design and installation of cast iron soil pipe. The Cast Iron Soil Pipe Institute handbook is also an excellent reference for engineers.

In-slab Installation

Although cast iron soil pipe, fittings, couplings and gaskets are unaffected by direct contact with concrete, care must be taken to properly support any piping system when pouring concrete so that the weight of the concrete does not affect the piping system. While not required due to any corrosion issues, a good practice to aid in any future maintenance or excavation of a system would be to loosely wrap both hub-and-spigot joints and hubless couplings with polyethylene sheet so that concrete does not become imbedded into crevices, shields or clamps on couplings.

Some codes require sleeving or protection of piping at slab penetrations. While not necessary due to any corrosion issues, always follow applicable code requirements on any installation.

ABOVE GROUND INSTALLATION PROCEDURES

! WARNING

Unsecured piping can fall and cause serious injury. Always properly support and secure piping to help prevent injury. Always wear protective clothing, including hard hats, during installation.

Installing Vertical Piping

1. Secure vertical piping at intervals sufficiently close to maintain correct pipe alignment and to support the weight of the pipe and its contents. Support stacks at their bases and at sufficient floor intervals to meet the requirements of local codes. Use approved riser clamps, floor clamps, or friction clamps for this purpose. If the building is over two stories in height, support the stack at the base and at each floor with an approved clamp.

! WARNING

Failure to follow proper installation practices, procedures, or techniques may result in personal injury, system failure or property damage.

- Always use protective equipment including eye protection and safety clothing while installing or cutting pipe.
- Power equipment can be dangerous if used improperly. Always review and carefully follow the manufacturer's operating and safety instructions.

INSTALLATION PROCEDURES FOR CAST IRON

2. If vertical pipe is required to stand free of any support by design specifications, or if no structure is available for support and stability during construction, secure the piping in its proper position with metal stakes and braces fastened to the pipe. Support the weight of vertical pipe risers at the point or points above and closest to their center of gravity.

Installing Horizontal Piping—Suspended

Horizontal pipe and fittings five (5) inches and larger must be suitably restrained to prevent horizontal movement and possible joint separation. This must be done at every branch opening or change in direction by the use of a brace, block, rodding or other suitable method, to prevent movement or joint separation.

 **WARNING**

Unsecured piping can fall and cause serious injury. Always properly support and secure piping to help prevent injury. Always wear protective clothing, including hard hats, during installation.

1. Support horizontal piping and fittings at intervals sufficiently close to maintain correct pipe alignment and to prevent sagging or grade reversal. Support each length of pipe with an approved hanger located as close to the joint as possible, and not more than 18 inches from the joint. For 12" and 15" hubless pipe, hangers should be placed on both sides of the coupling when installing full ten-foot lengths. Installation requiring multiple joints within a four foot developed length shall be supported at every other or alternating couplings.
2. Support terminal ends of all horizontal runs or branches, and each change of direction or alignment, with an approved hanger.
3. Firmly secure all closet bends installed above ground.
4. Most plumbing codes require that five-foot pipe be supported at five-foot intervals, and that ten-foot pipe be supported at ten-foot intervals. Support each length of pipe properly in accordance with all applicable codes to prevent sagging and misalignment.
5. When installing large-diameter horizontal piping (five inches or larger), restrain joints to prevent horizontal movement. Use sway bracing as needed to stabilize side movement of the piping system. Use blocks, rods, bracing or other suitable methods at each branch opening or change in direction. Examples of restraints are shown here:

NOTE: Engineers, designers and installers should use additional references concerning hanging, restraint and support of pipe in the Cast Iron Soil Pipe Handbook published by the Cast Iron Soil Pipe Institute (www.cispi.org) and/or the ASPE Plumbing Engineering Design Handbook, chapter 6, Hangers and Support in Vol. 4, published by the American Society of Plumbing Engineers (www.aspe.org).

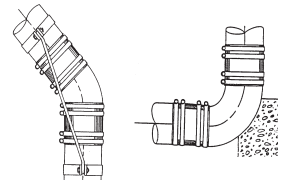

Installing Horizontal Fittings

NOTE: The following procedures are intended only as general guidelines. Specific installation instructions and techniques may be required as a result of applicable plumbing and building codes, engineering specifications and instructions.

1. Use hangers as required to provide proper alignment and grade. Install a hanger at every horizontal branch connection. Always install hangers within 18 inches of the joint to maintain correct system alignment and to prevent structural sagging. For 12" and 15" hubless pipe, hangers should be placed on both sides of the coupling when installing full ten-foot lengths. Installation requiring multiple joints within a four-foot developed length shall be supported at alternating couplings. The correct spacing of hangers will enable proper piping system grade.
2. Use sway bracing, as needed, to stabilize hanging systems against horizontal movement. Sway bracing is a non-rigid form of structural support that is well suited to installations in which components hang from a height greater than 18 inches.
3. The following components should be stabilized from movement in any direction: closet bends; traps; trap-arms; all similar branches. Closet bends installed above ground must be stabilized. Stabilize all vertical closet stubs against all vertical and horizontal movement.
4. When a hubless blind plug is used for a required cleanout, the complete coupling and plug must be accessible for removal and replacement.
5. Use caulked lead and oakum or compression joints to connect closet rings, floor drains, shower drains, similar slip-over fittings, and hubless pipe and fittings to soil pipe hubs.

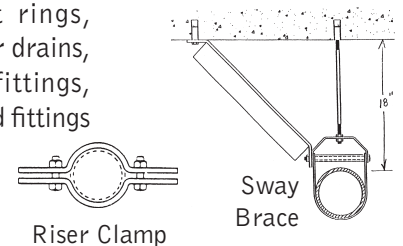

It is important to test all cast iron piping installations for leaks after the roughing-in has been completed. Before testing, the installer should notify the inspector of the local administrative authority having jurisdiction over plumbing installations. Leave concealed work uncovered until the required tests are performed and the system receives approval.

 **WARNING**

Testing with or use of compressed air or gas in Cast Iron pipe or fittings can result in explosive failures and cause severe injury or death.

AIR/GAS



- NEVER test with or transport/store compressed air or gas in Cast Iron pipe or fittings.
- NEVER test Cast Iron pipe or fittings with compressed air or gas.
- ONLY use Cast Iron pipe and fittings for drain, waste and vent or sanitary sewer applications.

Various procedures are used to test installed cast iron soil pipe and fitting systems. They include the use of water (hydrostatic), smoke, and peppermint.

For testing purposes, the system should be properly restrained at all bends, changes of direction, and ends of runs.

 **WARNING**

Use proper safety procedures, equipment, eye-wear and clothing during any testing procedures.

Note: In all installations, installers should be aware of local conditions, codes and regulations. Comply with all local codes, regulations, manufacturers' instructions and architect/engineer specifications.

Water or Hydrostatic Testing

This is the most common type of test used to test a completed cast iron soil pipe installation, and it is the test most often recommended by plumbing codes. Its purpose is to check the installation for leaks and to correct these prior to putting the system into service. Use the following steps to perform a water test:

1. Since visual inspection of the system is required, conduct this test prior to enclosing above-ground installations, or backfilling below-ground installations.
2. Isolate each floor or section being tested by inserting plugs into the test tees in the stacks.
3. Plug or cap all other openings with test plugs or test caps.

 **WARNING**

Horizontal pipe and fittings five (5) inches and larger must be suitably braced to prevent horizontal movement. This must be done at every branch opening or change in direction by the use of a brace, block, rodding or other suitable method, to prevent movement or joint separation. Heavy Duty or wide body couplings are not a substitute for proper thrust restraint. Failure to properly restrain branch openings or changes in direction will result in joint movement or separation, causing system failure and potential serious injury.

4. Fill the system with water at its highest point. Do this slowly to allow any trapped air to escape as the water level rises. Note: Failure to remove entrapped air may cause faulty test results, so be sure all entrapped air has been removed to obtain reliable test results.
5. As water fills a vertical pipe, it creates hydrostatic pressure. This pressure increases as the height of the water in the vertical pipe increases. Charlotte Pipe recommends water testing with ten feet of hydrostatic pressure (4.3 pounds per square inch).
6. After filling the stack to ten feet of head, visually inspect the section you are testing for any leaks around its joints.
7. In hubless systems, leaks can often be traced to hubless couplings that were not tightened properly to the recommended torque. In these cases, correctly tightening the couplings should eliminate the leak.
8. If leaks are detected in hub and spigot systems, disassemble the joints and check to determine if the correct installation procedures were used.
9. Water test each portion of the system for 15 minutes. This is sufficient time for any problems to be detected.
10. After a successful test, drain the system and prepare the next section for testing.

TESTING AND INSPECTION

THRUST FORCES

Thrust or displacement forces are encountered as the pipe is filled with water. The higher the fill, the greater the force acting to separate a joint. The table below shows the pounds of force tending to cause joint separation when using pipe from 1-1/2" to 15" and a head of water from 10 feet to 120 feet.

Thrust or Displacement Forces Encountered in Hydrostatic Testing of Cast Iron Soil Pipe

Pipe Size		1 1/2"	2"	3"	4"	5"	6"	8"	10"	12"	15"
Head, Feet of Water	Pressure PSI	Thrust lb.	Thrust lb.	Thrust lb.	Thrust lb.	Thrust lb.	Thrust lb.	Thrust lb.	Thrust lb.	Thrust lb.	Thrust lb.
10	4.3	12	19	38	65	95	134	237	377	538	847
20	8.7	25	38	77	131	192	271	480	762	1088	1714
30	13.0	37	56	115	196	287	405	717	1139	1636	2562
40	17.3	49	75	152	261	382	539	954	1515	2164	3409
50	21.7	62	94	191	327	479	676	1197	1900	2714	4276
60	26.0	74	113	229	392	574	810	1434	2277	3252	5124
70	30.3	86	132	267	457	668	944	1671	2654	3790	5971
80	34.7	99	151	306	523	765	1082	1914	3039	4340	6838
90	39.0	111	169	344	588	860	1216	2151	3416	4878	7685
100	43.4	123	188	382	654	957	1353	2394	3801	5429	8552
110	47.7	135	208	420	719	1052	1487	2631	4178	5967	9400
120	52.0	147	226	458	784	1147	1621	2868	4554	6505	10247
AREA, OD, in. ²		2.84	4.34	8.81	15.07	22.06	31.17	55.15	87.58	125.09	197.06

Thrust = Pressure x Area

WARNING

Horizontal pipe and fittings five (5) inches and larger must be suitably braced to prevent horizontal movement. This must be done at every branch opening or change in direction by the use of a brace, block, rodding or other suitable method, to prevent movement or joint separation. Heavy Duty or wide body couplings are not a substitute for proper thrust restraint. Failure to properly restrain branch openings or changes in direction will result in joint movement or separation, causing system failure and potential serious injury.

The Smoke Test

Should a smoke test be specified by an engineer, architect, or plumbing code, proceed as follows:

1. Permanently connect all fixtures and fill all traps with water.
2. Be prepared to test all parts of the plumbing drainage and ventilation system.
3. Close all windows in the building until the test has been completed.
4. Fill the system with a thick, penetrating smoke that has been generated by one or more smoke-producing machines.
5. When smoke begins to appear at the stack opening on the roof, close off that opening.

WARNING

To reduce the risk of fire, smoke inhalation, chemical inhalation or burns, never use chemical mixtures for producing smoke. These mixtures may be dangerous and can cause serious personal injury.

6. Continue filling the system with smoke until a pressure equal to one inch of water is built up.
7. Maintain this pressure for fifteen minutes or longer, as required to test the entire system.
8. Check all components of the system to help ensure that smoke is not escaping. Smoke should not be visible at any point, connection, or fixture.

The Peppermint Test

This test is most often used in older installations to detect faulty plumbing.

1. Permanently connect all fixtures and fill all traps with water.
2. Be prepared to test all parts of the plumbing drainage and ventilation system.
3. Close all windows in the building until the test has been completed.
4. Mix two ounces of peppermint oil with one gallon of hot water.
5. Pour the mixture into the system's roof opening.
6. Tightly close the roof opening.
7. Have a person other than the one that poured the mixture into the system inspect the system for any odor of peppermint.
8. Inspect all system points, connections, and fixtures. There should be no odor of peppermint within the building.

WARNING

Testing with or use of compressed air or gas in Cast Iron pipe or fittings can result in explosive failures and cause severe injury or death.

AIR/GAS



- NEVER test with or transport/store compressed air or gas in Cast Iron pipe or fittings.
- NEVER test Cast Iron pipe or fittings with compressed air or gas.
- ONLY use Cast Iron pipe and fittings for drain, waste and vent or sanitary sewer applications.

HOW TO DETERMINE RIGHT OR LEFT HAND INLETS

Use the following illustrations and descriptions to determine whether a fitting has a right- or left-hand inlet.



- **Closet Bends and P Traps** — Place the inlet upright near you, with the spigot facing away. If the side inlet is on your right, it is a right-hand inlet.



- **All Branch Fittings** — Place the spigot near you, with the branch facing upwards. If the side inlet is on your right, it is a right-hand inlet.
- **All Bends** — Place the fitting upright, with the spigot near you. If the side inlet is on your right, it is a right-hand inlet.

PAINTING CAST IRON SOIL PIPE

If desired, Charlotte Pipe's cast iron soil pipe and fittings can be painted to coordinate with surrounding surfaces.

WARNING

To reduce the risk of serious injury, carefully review and follow the paint manufacturer's instructions.

- Always allow proper ventilation of paint fumes and avoid eye or skin contact.
- Use extreme caution near sparks, heat or open flame.
- In case of an accident, follow the hazardous warning and treatment statements printed on the paint container label.

Follow these steps for a high-quality painted finish:

1. Clean the pipe's surface of all dirt, oil and grease.
2. Apply a primer coat of high-quality, oil-based primer paint. Allow it to dry according to the paint manufacturer's specifications.
3. Apply a top coat of high-quality, oil-based enamel paint. Allow the painted components to dry according to the paint manufacturer's specifications before handling them.

SIPHONIC ROOF DRAINS

Instructions from the manufacturer of the siphonic roof drains and applicable local plumbing and building codes should be followed.

NOTE: These drains produce both positive and negative pressure at elevated velocity, and the specifier or engineer designing the system should specify piping products meeting the requirements of the application. Charlotte Pipe recommends contacting the manufacturer of these drains for recommendations. Providing appropriate thrust restraints and anchors is crucial.

See ASPE Standard 45-Siphonic Roof Drainage for additional information.

MATERIAL SELECTION AND ENGINEERING CONSIDERATIONS

MATERIAL SELECTION AND ENGINEERING CONSIDERATIONS

Throughout the years engineers, inspectors, installers, and building owners have recognized cast iron as the best material for use in drain, waste, vent, and storm piping applications. There are many different alternative materials utilized in these systems with varying degrees of success, but cast iron has remained the industry standard. Some general considerations are listed below.

Maximum Working Temperature

Plumbing codes restrict discharges into sanitary lines to 140° F, but the reality is that commercial kitchens and equipment discharges can sometimes exceed these temperatures guidelines. Cast iron soil pipe with neoprene gaskets has a maximum working temperature of 212° F.

Thermal Expansion

Cast iron soil pipe and fittings will expand 0.745" per 100 feet of pipe with a 100° F temperature change. The movement of cast iron is close to that of structural steel and concrete, meaning it literally "moves with the building" and usually requires no compensation for expansion or contraction.

Sound Attenuation

A material's ability to block the transmission of sound is a function of the material's density. Cast iron soil pipe and fittings are very dense due to the molecular structure. Sound attenuation is especially important in main drainage stacks and storm systems in multi-family housing, office buildings, dwellings where individuals spend the night (hotels and hospitals) and in classroom settings.

Burial of Cast Iron

The term "crush strength" or "crush rating" derives from rigid pipe such as cast iron and refers to its ultimate strength at rupture. These terms do not apply to thermoplastic pipe which is classified as a flexible conduit in civil engineering terms. Rigid piping materials like cast iron soil pipe fail when it crushes and specific strength charts are published irrespective of soil, bedding or backfill. Reference charts for burial of cast iron soil pipe are available in The Cast Iron Soil Pipe Handbook which can be found at www.cispi.org.

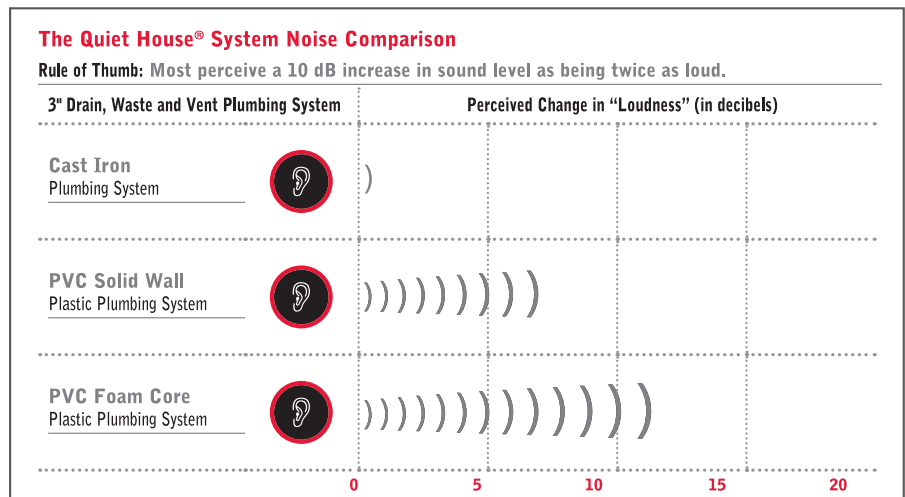
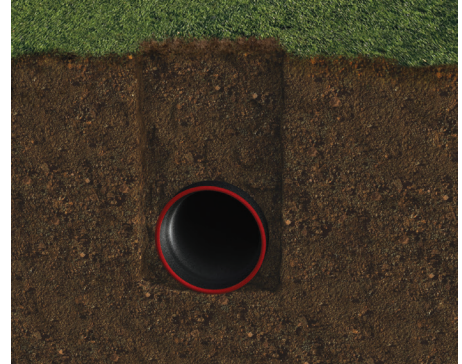

Quiet House is a registered trademark of Charlotte Pipe and Foundry Company.

Hanger Spacing & Fall

Properly installed DWV piping systems require consistent fall without flat or low points in the piping system that can impede flow. Model Plumbing Codes require PVC DWV pipe to be supported horizontally every 4 feet. Cast iron soil pipe and fitting offer greater structural strength, which significantly reduces hanger requirements and provides consistent fall. Cast iron soil pipe and fittings only needs to be supported within 18" of each joint and every 10 feet horizontally.

Combustibility & Use in Plenum Spaces

Combustibility of construction materials is defined by ASTM E 136 and is a consideration for selection of materials when penetrating fire-separations or for inclusion in un-ducted return air plenum spaces. Materials classified as combustible must pass the ASTM E 84 test protocol with index values of less than 25 flame spread and 50 smoke developed. Cast iron soil pipe and fittings are classified as non-combustible and can be installed in plenum areas without further consideration. Because cast iron soil pipe and fittings are non-combustible, they will not burn away leaving a hole in the fire-rated assembly. Therefore, installers are only required to seal the annular space between the wall and the pipe when cast iron pipe penetrates fire-rated assemblies. Typically mineral wool batting and fire-resistant caulking are used to fill the annular space.

Engineered Applications

Over the past few years many new innovations have been introduced to the industry including siphonic roof drainage, solvent, air admittance devices and other products. Some of these products do not conform to existing standards or to the requirements of the model plumbing codes. Rather, they are designed into the system by engineers and approved as an alternate material within the code.

Charlotte Pipe and Foundry manufactures pipe and fitting systems that conform to published ASTM and Cast Iron Soil Pipe Institute standards. Products are warranted to conform to the requirements of applicable standards when used for the applications defined within these standards. Charlotte Pipe and Foundry will not accept liability for applications that do not conform to the standards to which we manufacture.

The Original Green Piping System

Cast iron soil pipe and fittings are made from recycled scrap iron and steel. Each year we prevent more than 350 million pounds of scrap iron and steel from entering overcrowded landfills by converting it into cast iron soil pipe and fittings. Additionally, at the end of the life of a building, the cast iron piping can be recovered and recycled again to make new cast iron pipe and fittings or other metallic products. Charlotte Pipe and Foundry Company certifies that its cast iron soil pipe and fitting products are made from 96% post-consumer recycled material (0% post-industrial material).

LIMITED WARRANTY

Cast Iron Installation

Charlotte Pipe and Foundry Company® (Charlotte Pipe®) Products are warranted to be free from manufacturing defects and to conform to currently applicable ASTM standards for a period of five (5) years from date of delivery. Buyer's remedy for breach of this warranty is limited to replacement of, or credit for, the defective product. This warranty excludes any expense for removal or reinstallation of any defective product and any other incidental, consequential, or punitive damages. **This limited warranty is the only warranty made by seller and is expressly in lieu of all other warranties, express and implied, including any warranties of merchantability and fitness for a particular purpose.** No statement, conduct or description by Charlotte Pipe or its representative, in addition to or beyond this Limited Warranty, shall constitute a warranty. This Limited Warranty may only be modified in writing signed by an officer of Charlotte Pipe.

This Limited Warranty will not apply if:

- 1) The Products are used for purposes other than their intended purpose as defined by local plumbing and building codes, and the applicable ASTM standard.
- 2) The Products are not installed in good and workmanlike manner consistent with normal industry standards; installed in compliance with the latest instructions published by Charlotte Pipe and good plumbing practices; and installed in conformance with all applicable plumbing, fire and building code requirements.
- 3) This limited warranty does not apply when the products of Charlotte Pipe are used with the products of other manufacturers that do not meet the applicable ASTM or CISPI standards or that are not marked in a manner to indicate the entity that manufactured them.
- 4) In hubless cast iron installations, this warranty will not apply if products are joined with unshielded hubless couplings. Charlotte Pipe requires that its hubless cast iron pipe and fittings be joined only with shielded hubless couplings manufactured in accordance with CISPI 310, ASTM C 1277 and certified by NSF® International or with Heavy Duty Couplings meeting ASTM C 1540.
- 5) The Products fail due to defects or deficiencies in design, engineering, or installation of the piping system of which they are a part.
- 6) The Products have been the subject of modification; misuse; misapplication; improper maintenance or repair; damage caused by the fault or negligence of anyone other than Charlotte Pipe; or any other act or event beyond the control of Charlotte Pipe.
- 7) The Products fail due to the freezing of water in the Products.
- 8) The Products fail due to contact with chemical agents, fire stopping materials, thread sealant, plasticized vinyl products, or other aggressive chemical agents that are not compatible.
- 9) Pipe outlets, sound attenuation systems or other devices are permanently attached to the surface of Charlotte® PVC, ABS or CPVC products with solvent cement or adhesive glue.

Charlotte Pipe products are manufactured to the applicable ASTM or CISPI standard. Charlotte Pipe and Foundry **cannot** accept responsibility for the performance, dimensional accuracy, or compatibility of pipe, fittings, gaskets, or couplings not manufactured or sold by Charlotte Pipe and Foundry.

This Limited Warranty will not apply unless written notice of a claim is mailed to Charlotte Pipe at the address below within 30 days of discovery of the allegedly defective product.

Any Charlotte Pipe products alleged to be defective **must** be made available to Charlotte Pipe at the following address for verification, inspection and determination of cause:

Charlotte Pipe and Foundry Company
Attention: Technical Services
2109 Randolph Road
Charlotte, North Carolina 28207

Purchaser must obtain a return materials authorization and instructions for return shipment to Charlotte Pipe of any product claimed defective or shipped in error.

Any Charlotte Pipe product **proved** to be defective in manufacture will be replaced F.O.B. point of original delivery, or credit will be issued, at the discretion of Charlotte Pipe.

4/20/21

Charlotte, Charlotte Pipe and "You can't beat the system" are registered trademarks of Charlotte Pipe and Foundry Company.

A BRIEF HISTORY

In 1901 W. Frank Dowd built a small foundry in Charlotte, North Carolina to produce cast iron pipe and fittings for plumbing in the newly industrialized, post-war south. Armed with wheelbarrows, shovels, and muscle, the foundry's twenty-five workers produced eight to ten tons of cast iron soil pipe and fittings a day.

W. Frank Dowd, II took over management of the company upon his father's death in 1926. Over the next two decades, he worked hard to expand the marketing territory of Charlotte Pipe and Foundry and lay the groundwork for strong customer relations and service that remains the hallmark of the company.

His two sons, W. Frank Dowd, Jr. and Roddey Dowd, Sr. joined the company in the early 1950s and presided over the mechanization of the soil pipe facilities. This sweeping modernization kept Charlotte Pipe at the forefront of the cast iron industry when many of its competitors were floundering.

Today, the founder's great grandsons Frank Dowd, IV and Roddey Dowd, Jr. continue the strong commitment to manufacturing quality products and delivering excellent customer service. An experienced group of officers helps provide effective leadership. Combined, the 12-member team has more than 230 years of service dedicated to the company. Through their commitment, and by working together efficiently, this team ensures that Charlotte Pipe is on track to serve its customers' needs.

As we look forward to our second century of business in the plumbing industry, the company faces new challenges. But the one constant set by the founder remains the same: Make the best quality products, and back them up with excellent service.

You can't beat the system.®

To the best of our knowledge the information contained in this publication is accurate. However, Charlotte Pipe and Foundry does not assume any liability whatsoever for the accuracy or completeness of such information. Final determination of the suitability of any information or product for the use to be contemplated is the sole responsibility of the user. The manner of that use and whether there is any infringement of patents is also the sole responsibility of the user.

CHARLOTTE

PIPE AND FOUNDRY COMPANY®

PO BOX 35430

CHARLOTTE

NORTH CAROLINA 28235

PHONE (704) 348-6450

(800) 438-6091

FAX (800) 553-1605

WWW.CHARLOTTEPIPE.COM



All products manufactured by
Charlotte Pipe and Foundry Company
are proudly made in the U.S.A.